

*Dynalton*<sup>®</sup>  
*Labware*  
quality . value . service



Laboratory Supplies  
and Equipment



Heatable PTFE Beakers

Page 12

### Beakers: 9 - 12

- Beakers with Handles
- Printed Square Ratio Beakers
- Griffin Style Molded Beakers
- Tapered PP, PMP & PTFE Beakers
- Heatable PTFE Beakers

### Bottles: 17 - 32

- Plastic Laboratory Bottles
- Rectangular & Square Bottles
- Tamper Evident Plastic Bottles
- Concertina Collapsible Bottle
- Plastic Dispensing Bottles
- Plastic Wash Bottles
- PTFE Bottle Pourers



NEW Straight-Side Containers  
PETE with White PP Closures  
Page 39



NEW Polycarbonate Graduated Bottles with PP Closures Page 21

### Containers: 38 - 42

- Screw Cap Plastic Jars & Containers
- Snap Cap Plastic Jars & Containers
- Hinged Lid Plastic Containers
- Dispensing Plastic Containers
- Graduated Plastic Containers
- Disposable Plastic Containers

### Cylinders: 45 - 48

- Clear Plastic Cylinder, PMP
- Translucent Plastic Cylinder, PP
- Short Form Plastic Cylinder, PP
- Four Liter Plastic Cylinder, PP
- Certified Plastic Cylinder, PMP
- Hydrometer Jar, PP
- Conical Shape Plastic Cylinder, PP



Printed Cylinders Page 47

### Disposal Boxes: 54 - 55

- Bio-bin Waste Disposal Containers
- Glass Disposal Boxes
- Burn-up™ Bins
- Plastic Recycling Boxes
- Non-Hazardous Disposal Boxes



Burn-up™ Bins

Page 54

### Drying Racks: 55 - 56

- Kartell Plastic Drying Rack, High Impact PS
- Dynalon Mega-Peg Plastic Drying Rack
- Azlon Epoxy Coated Drying Rack
- Plastic Draining Baskets
- Custom Size Drying Racks Available

Dynalab Labware, a leading wholesaler of plastic lab supplies throughout North America, is the wholesale division of Dynalab Corp. Founded in 1957, Dynalab Labware is proud to be your **supplier of choice for over 50 years.**

2	Catalog Introduction	55 - 56	Drying Racks	80 - 81	Shields
2 - 7	Technical Plastic Properties	56	Evaporating Dishes	81 - 83	Slide Accessories
8	Bags, Bag Ties & Baritainers	56	Eye Wash Station	83 - 84	Spatulas
9 - 12	Beakers, Beakers with Handle	57 - 59	Flasks	84	Spigot, Sponge, Spot Plates
13 - 17	Beta Radiation Protection	60	Forceps	85	Spot Plates
17 - 32	Bottles and Accessories	60 - 63	Funnels	85 - 88	Stirring Bars and Accessories
32	Bucket, Ice	63	Gamma Protection Products	88 - 89	Stirrers
33	Burettes	64	Glass Sleeves, Hydrometer	89	Stopcocks
34 - 37	Carboys	64	Imhoff	90	Swabs, Tape, Thermal Cyclers
38	Chiller	65	Innoculating	91 - 92	Tote Boxes
38	Clamps	65 - 66	Labels	92 - 95	Trays
38 - 42	Containers	67	Matting	95	Tubes
42	Crucibles	68	Melting Point Apparatus	96 - 99	Tube Racks
43	Cutting Boards	68 - 69	Paddles	99 - 100	Tubing
43 - 45	Cuvettes and accessories	69 - 70	Pails	100 - 102	Tubing Accessories
45 - 48	Cylinders and accessories	70	Parafilm Dispenser, Petri	103	Tweezers
48	Delivery Tubes	71	Pipettes	103 - 104	Vials
49 - 50	Desiccators	72 - 73	Pipette Accessories	104 - 105	Vial Racks
50	Detergent	73	Pipette Tips	105	Watch Glass, Water Still
50	Dippas <sup>®</sup>	74 - 75	Pipettors Accessories	106	Weighing Bottles
51	Dippers	76	Pumps	106 - 107	Wip, Wipe Dispensers
52 - 53	Dipping Baskets	77	Racks	108 - 111	Index
54 - 55	Disposal Boxes	78 - 79	Sample Cups, Samplers	112	Custom Plastic Fabrication
55	Droppers	79 - 80	Scoops		

### Labware Starter Kit

This versatile pack contains over 45 safe and popular plastic labware products for young scientists especially in Elementary, Middle and High schools. Teach storage, measurement, pipeting, dispensing etc. in both English and metric. Duplicate products allow sharing amongst students.

Item	Polymer	Description	Quantity
237755	PMP	Transparent Economy Molded Cylinder, 50mL	1
237765	PMP	Transparent Economy Molded Cylinder, 100mL	1
237775	PMP	Transparent Economy Molded Cylinder, 250mL	1
226415-0070	HDPE	Cylindrical Jar with Screw Closure & Insert, 70mL	1
226415-0500	HDPE	Cylindrical Jar with Screw Closure & Insert, 500mL	1
226415-1000	HDPE	Cylindrical Jar with Screw Closure & Insert, 1000mL	1
259845	HDPE	Test Tube Rack, Two Tier, for up to 18mm Tubes	1
262175	LDPE	Droppers, Bellow-Type Bulb, 1.5mL	5
262185	LDPE	Droppers, Bellow-Type Bulb, 5.0mL	5
299334-000B	PP/LDPE	Test Tube/Centrifuge Tube, Blue Closure, 16mm	2
299334-000R	PP/LDPE	Test Tube/Centrifuge Tube, Red Closure, 16mm	2
299334-000W	PP/LDPE	Test Tube/Centrifuge Tube, White Closure, 16mm	2
299334-000Y	PP/LDPE	Test Tube/Centrifuge Tube, Yellow Closure, 16mm	2
412575	NYL	Spatula/Stirrer 10"	3
426364-07	PS	Transparent Container w/ Snap-on Cap, 7Dram/24mL	3
501505-0125	PP	Graduated Bottle Wide Mouth w/ Marking Area, 125mL	1
501505-0250	PP	Graduated Bottle Wide Mouth w/ Marking Area, 250mL	1
502754-02	PS	Pipette Graduated 2mL	5
506805-0250	LDPE	Wash Bottle Narrow Mouth Sloped w/ White Clsr 250mL	1
522085-0100	PP	Printed "Square Ratio" Beaker, 100mL	1
522085-0250	PP	Printed "Square Ratio" Beaker, 250mL	1
326495-0500	PP	Beaker with Handle, 500mL	1
537835-0100	PP	Graduated Cylinder w/ Graduations, Squat Form, 100mL	1
542365-04	PP	Lightweight Funnels, 50mm ID	1
605085-0005	LDPE	Dispensing Bottle 15mL	1
605085-06	LDPE	Dispensing Bottle 180mL	1

Lab Starter Pack      Labware Starter Pack      \$100.03 each



# Plastics properties &

## Introduction

The Dynalon® catalog technical section aims to provide clear, concise information about the key polymers from which our ranges are manufactured. It is intended as your guide to the suitability of our products for use with a variety of chemical groups, and in a variety of environments.

Each polymer has its own entry with detailed technical information and a summary icon denoting its general chemical suitability characteristics. Those Polymers capable of being repeatedly Autoclaved at, at least 121°C for 30 minutes are denoted by the letter A, more detailed temperature resistance is often included in the text.

The information within this section is designed to answer most common application questions but like any guide will not answer all. Dynalon's Technical Department will be pleased to answer any question relating to product usage.

## LDPE (Low Density Polyethylene)

- Translucent naturally flexible polymer
- Temperature range of -50 to +80°C
- Not autoclavable
- Good to excellent chemical resistance
- Robust and virtually unbreakable
- Used for wash bottles, storage bottles, transfer pipettes, vials

**Excellent resistance (no attack)** to dilute and concentrated Acids, Alcohols, Bases and Esters.

**Good resistance (minor attack)** to Aldehydes, Ketones and Vegetable Oils.

**Limited resistance (moderate attack)** suitable for short term use only) to Aliphatic and Aromatic Hydrocarbons, Mineral Oils and Oxidizing Agents.

**Poor resistance and not recommended** for use with Halogenated Hydrocarbons.

### quick facts

Maximum Temperature: 176°F (80°C)

Minimum Temperature: -58°F (-50°C)

Autoclavable: No

UV Resistance: Poor

Translucent with Excellent flexibility

**Recycling Code: 4**

### LDPE



## HDPE (High Density Polyethylene)

- Translucent rigid polymer
- Temperature range of -100 to +120°C
- Not autoclavable
- Good to excellent chemical resistance
- High impact resistance
- Used for storage bottles, containers and jars

**Excellent resistance (no attack)** to dilute and concentrated Acids, Alcohols and Bases.

**Good resistance (minor attack)** to Aldehydes, Esters, Aliphatic and Aromatic Hydrocarbons, Ketones and Mineral and Vegetable Oils.

**Limited resistance (moderate attack)** and suitable for short term use only) to Halogenated Hydrocarbons and Oxidizing Agents.

### quick facts

Maximum Temperature: 248°F (120°C)

Minimum Temperature: -148°F (-100°C)

Autoclavable: No

UV Resistance: Poor

Translucent and Rigid

**Recycling Code: 2**

### HDPE



# chemical resistance

## PP (Polypropylene)

- Translucent rigid polymer
- Temperature range 0 to +135°C
- Autoclavable (repeatedly)
- Good to excellent chemical resistance
- Impact resistant
- Used for beakers, bottles, cylinders and screw closures

**Excellent resistance (no attack)** to most Acid solutions, Alcohols, Bases and Mineral Oils.

**Good resistance (minor attack)** to Aldehydes, Esters, Aliphatic Hydrocarbons, Ketones & Vegetable Oils.

**Limited resistance (moderate attack)** and suitable for short term use only) to Aromatic and Halogenated Hydrocarbons and Oxidizing Agents.

### quick facts

Maximum Temperature: 275°F (135°C)

Minimum Temperature: 32°F (0°C)

Autoclavable: Yes

UV Resistance: Poor

Translucent and Rigid

**Recycling Code: 5**

*PP*

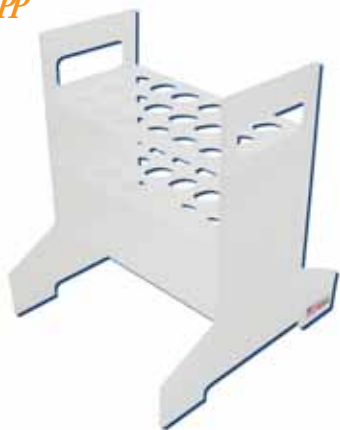

## PMP (Polymethylpentene)

- Transparent rigid polymer
- Temperature range 0 to +145°C
- Autoclavable
- Good to excellent chemical resistance
- Glass like clarity
- Used for transparent beakers and cylinders

**Excellent resistance (no attack)** to dilute and concentrated Acids, Alcohols, Bases and Mineral Oils.

**Good resistance (minor attack)** to Aldehydes, Esters, and Vegetable Oils.

**Limited resistance (moderate attack)** and suitable for short term use only) to Aliphatic and Aromatic Hydrocarbons, Ketones and Oxidizing Agents.

**Poor resistance not recommended** for use with Halogenated Hydrocarbons.

### quick facts

Maximum Temperature: 293°F (145°C)

Minimum Temperature: 32°F (0°C)

Autoclavable: Yes

UV Resistance: Poor

Clear and Rigid

**Recycling Code: 7**

*PMP*



## PS (Polystyrene)

- Transparent rigid polymer
- Temperature range -10 to +70°C
- Not autoclavable
- Moderate chemical resistance
- Brittle yet has excellent clarity
- Used for petri dishes, pipettes and container ware

**Excellent resistance (no attack)** to dilute Acids, Alcohols and Mineral Oils.

**Good resistance (minor attack)** to Vegetable Oils.

**Limited resistance (moderate attack)** and suitable for short term use only) to concentrated Acids.

**Poor resistance not recommended** for use with Aldehydes, Esters, Aliphatic, Aromatic and Halogenated Hydrocarbons, Ketones and Oxidizing Agents.

### quick facts

Maximum Temperature: 158°F (70°C)

Minimum Temperature: 32°F (0°C)

Autoclavable: No

UV Resistance: Good

Clear and Rigid

**Recycling Code: 6**

*PS*



# Properties of Plastic

● Excellent resistance no attack    
 ● Good resistance minor attack    
 ● Limited resistance moderate attack    
 ● Poor resistance, attacked or dissolved, not recommended    
 ● No information available

Reagent	LDPE		HDPE		PP		PMP		PVC		PC		PS		SAN		ABS		ACRYLIC		PTFE		PFA		E-CTFE	
	20	50	20	50	20	50	20	50	20	50	20	50	20	50	20	50	20	50	20	50	20	50	20	50	20	50
Temperature °C	20	50	20	50	20	50	20	50	20	50	20	50	20	50	20	50	20	50	20	50	20	50	20	50	20	50
Temperature °F	68	122	68	122	68	122	68	122	68	122	68	122	68	122	68	122	68	122	68	122	68	122	68	122	68	122
Acetaldehyde	●	●	●	●	●	●	●	●	●	●	●	●	●	●	●	●	●	●	●	●	●	●	●	●	●	●
Acetic Acid	●	●	●	●	●	●	●	●	●	●	●	●	●	●	●	●	●	●	●	●	●	●	●	●	●	●
Acetic Anhydride	●	●	●	●	●	●	●	●	●	●	●	●	●	●	●	●	●	●	●	●	●	●	●	●	●	●
Acetone	●	●	●	●	●	●	●	●	●	●	●	●	●	●	●	●	●	●	●	●	●	●	●	●	●	●
Acetyl Chloride	●	●	●	●	●	●	●	●	●	●	●	●	●	●	●	●	●	●	●	●	●	●	●	●	●	●
Ammonium Chloride (10%)	●	●	●	●	●	●	●	●	●	●	●	●	●	●	●	●	●	●	●	●	●	●	●	●	●	●
Ammonium Hydroxide (28%)	●	●	●	●	●	●	●	●	●	●	●	●	●	●	●	●	●	●	●	●	●	●	●	●	●	●
Amyl Acetate	●	●	●	●	●	●	●	●	●	●	●	●	●	●	●	●	●	●	●	●	●	●	●	●	●	●
Aniline	●	●	●	●	●	●	●	●	●	●	●	●	●	●	●	●	●	●	●	●	●	●	●	●	●	●
Aqua Regia	●	●	●	●	●	●	●	●	●	●	●	●	●	●	●	●	●	●	●	●	●	●	●	●	●	●
Benzaldehyde	●	●	●	●	●	●	●	●	●	●	●	●	●	●	●	●	●	●	●	●	●	●	●	●	●	●
Benzene	●	●	●	●	●	●	●	●	●	●	●	●	●	●	●	●	●	●	●	●	●	●	●	●	●	●
Benzoic Acid	●	●	●	●	●	●	●	●	●	●	●	●	●	●	●	●	●	●	●	●	●	●	●	●	●	●
Boric Acid (10%)	●	●	●	●	●	●	●	●	●	●	●	●	●	●	●	●	●	●	●	●	●	●	●	●	●	●
Bromine Gas (Dry)	●	●	●	●	●	●	●	●	●	●	●	●	●	●	●	●	●	●	●	●	●	●	●	●	●	●
Bromine Water	●	●	●	●	●	●	●	●	●	●	●	●	●	●	●	●	●	●	●	●	●	●	●	●	●	●
Butyl Acetate	●	●	●	●	●	●	●	●	●	●	●	●	●	●	●	●	●	●	●	●	●	●	●	●	●	●
Butyl Alcohol	●	●	●	●	●	●	●	●	●	●	●	●	●	●	●	●	●	●	●	●	●	●	●	●	●	●
Butyric Acid	●	●	●	●	●	●	●	●	●	●	●	●	●	●	●	●	●	●	●	●	●	●	●	●	●	●
Calium Hydroxide (Saturated)	●	●	●	●	●	●	●	●	●	●	●	●	●	●	●	●	●	●	●	●	●	●	●	●	●	●
Carbon Disulphide	●	●	●	●	●	●	●	●	●	●	●	●	●	●	●	●	●	●	●	●	●	●	●	●	●	●
Carbon Tetrachloride	●	●	●	●	●	●	●	●	●	●	●	●	●	●	●	●	●	●	●	●	●	●	●	●	●	●
Chlorine Gas (Dry)	●	●	●	●	●	●	●	●	●	●	●	●	●	●	●	●	●	●	●	●	●	●	●	●	●	●
Chlorine Water	●	●	●	●	●	●	●	●	●	●	●	●	●	●	●	●	●	●	●	●	●	●	●	●	●	●
Chloroform	●	●	●	●	●	●	●	●	●	●	●	●	●	●	●	●	●	●	●	●	●	●	●	●	●	●
Citric Acid	●	●	●	●	●	●	●	●	●	●	●	●	●	●	●	●	●	●	●	●	●	●	●	●	●	●
m-Cresol	●	●	●	●	●	●	●	●	●	●	●	●	●	●	●	●	●	●	●	●	●	●	●	●	●	●
Cyclohexane	●	●	●	●	●	●	●	●	●	●	●	●	●	●	●	●	●	●	●	●	●	●	●	●	●	●
Dibutylphthalate	●	●	●	●	●	●	●	●	●	●	●	●	●	●	●	●	●	●	●	●	●	●	●	●	●	●
p-Dichlorobenzene	●	●	●	●	●	●	●	●	●	●	●	●	●	●	●	●	●	●	●	●	●	●	●	●	●	●
Diethyl Ether	●	●	●	●	●	●	●	●	●	●	●	●	●	●	●	●	●	●	●	●	●	●	●	●	●	●
Diethylene Glycol	●	●	●	●	●	●	●	●	●	●	●	●	●	●	●	●	●	●	●	●	●	●	●	●	●	●
Dimethyl Formamide	●	●	●	●	●	●	●	●	●	●	●	●	●	●	●	●	●	●	●	●	●	●	●	●	●	●
Dioxane	●	●	●	●	●	●	●	●	●	●	●	●	●	●	●	●	●	●	●	●	●	●	●	●	●	●
Ethyl Acetate	●	●	●	●	●	●	●	●	●	●	●	●	●	●	●	●	●	●	●	●	●	●	●	●	●	●
Ethyl Alcohol	●	●	●	●	●	●	●	●	●	●	●	●	●	●	●	●	●	●	●	●	●	●	●	●	●	●
Ethyl Chloride	●	●	●	●	●	●	●	●	●	●	●	●	●	●	●	●	●	●	●	●	●	●	●	●	●	●
Ethylene Chloride	●	●	●	●	●	●	●	●	●	●	●	●	●	●	●	●	●	●	●	●	●	●	●	●	●	●
Ethyl Oxide	●	●	●	●	●	●	●	●	●	●	●	●	●	●	●	●	●	●	●	●	●	●	●	●	●	●
Fluorine Gas (Dry)	●	●	●	●	●	●	●	●	●	●	●	●	●	●	●	●	●	●	●	●	●	●	●	●	●	●
Formaldehyde (Formalin)	●	●	●	●	●	●	●	●	●	●	●	●	●	●	●	●	●	●	●	●	●	●	●	●	●	●
Formic Acid	●	●	●	●	●	●	●	●	●	●	●	●	●	●	●	●	●	●	●	●	●	●	●	●	●	●
Fuel Oil	●	●	●	●	●	●	●	●	●	●	●	●	●	●	●	●	●	●	●	●	●	●	●	●	●	●

This chart gives general guidelines on the chemical resistance of plastics. There are many factors which influence chemical resistance.

● Excellent resistance no attack    ● Good resistance minor attack    ● Limited resistance moderate attack    ● Poor resistance, attacked or dissolved, not recommended    ● No information available

Reagent	LDPE		HDPE		PP		PMP		PVC		PC		PS		SAN		ABS		ACRYLIC		PTFE		PFA		E-CTFE		
	20	50	20	50	20	50	20	50	20	50	20	50	20	50	20	50	20	50	20	50	20	50	20	50	20	50	
Temperature °C	68	122	68	122	68	122	68	122	68	122	68	122	68	122	68	122	68	122	68	122	68	122	68	122	68	122	
Glycerine (Glycerol)	●	●	●	●	●	●	●	●	●	●	●	●	●	●	●	●	●	●	●	●	●	●	●	●	●	●	●
Hexane	●	●	●	●	●	●	●	●	●	●	●	●	●	●	●	●	●	●	●	●	●	●	●	●	●	●	●
Hydrobromic Acid (25%)	●	●	●	●	●	●	●	●	●	●	●	●	●	●	●	●	●	●	●	●	●	●	●	●	●	●	●
Hydrobromic Acid (35%)	●	●	●	●	●	●	●	●	●	●	●	●	●	●	●	●	●	●	●	●	●	●	●	●	●	●	●
Hydrofluoric Acid (35%)	●	●	●	●	●	●	●	●	●	●	●	●	●	●	●	●	●	●	●	●	●	●	●	●	●	●	●
Hydrogen Peroxide (30%)	●	●	●	●	●	●	●	●	●	●	●	●	●	●	●	●	●	●	●	●	●	●	●	●	●	●	●
Lactic Acid	●	●	●	●	●	●	●	●	●	●	●	●	●	●	●	●	●	●	●	●	●	●	●	●	●	●	●
Methyl Acetate	●	●	●	●	●	●	●	●	●	●	●	●	●	●	●	●	●	●	●	●	●	●	●	●	●	●	●
Methyl Alcohol	●	●	●	●	●	●	●	●	●	●	●	●	●	●	●	●	●	●	●	●	●	●	●	●	●	●	●
Methyl Ethyl Ketone	●	●	●	●	●	●	●	●	●	●	●	●	●	●	●	●	●	●	●	●	●	●	●	●	●	●	●
Methylene Chloride	●	●	●	●	●	●	●	●	●	●	●	●	●	●	●	●	●	●	●	●	●	●	●	●	●	●	●
Mineral Oil	●	●	●	●	●	●	●	●	●	●	●	●	●	●	●	●	●	●	●	●	●	●	●	●	●	●	●
Napthalene	●	●	●	●	●	●	●	●	●	●	●	●	●	●	●	●	●	●	●	●	●	●	●	●	●	●	●
Nitric Acid (10%)	●	●	●	●	●	●	●	●	●	●	●	●	●	●	●	●	●	●	●	●	●	●	●	●	●	●	●
Nitric Acid (70%)	●	●	●	●	●	●	●	●	●	●	●	●	●	●	●	●	●	●	●	●	●	●	●	●	●	●	●
Nitrobenzene	●	●	●	●	●	●	●	●	●	●	●	●	●	●	●	●	●	●	●	●	●	●	●	●	●	●	●
Oleum	●	●	●	●	●	●	●	●	●	●	●	●	●	●	●	●	●	●	●	●	●	●	●	●	●	●	●
Oxalic Acid	●	●	●	●	●	●	●	●	●	●	●	●	●	●	●	●	●	●	●	●	●	●	●	●	●	●	●
Perchloric Acid (20%)	●	●	●	●	●	●	●	●	●	●	●	●	●	●	●	●	●	●	●	●	●	●	●	●	●	●	●
Petrol	●	●	●	●	●	●	●	●	●	●	●	●	●	●	●	●	●	●	●	●	●	●	●	●	●	●	●
Petroleum Ether	●	●	●	●	●	●	●	●	●	●	●	●	●	●	●	●	●	●	●	●	●	●	●	●	●	●	●
Phosphoric Acid (85%)	●	●	●	●	●	●	●	●	●	●	●	●	●	●	●	●	●	●	●	●	●	●	●	●	●	●	●
Photographic Developer	●	●	●	●	●	●	●	●	●	●	●	●	●	●	●	●	●	●	●	●	●	●	●	●	●	●	●
Photographic Fixer	●	●	●	●	●	●	●	●	●	●	●	●	●	●	●	●	●	●	●	●	●	●	●	●	●	●	●
Potassium Hydroxide (50%)	●	●	●	●	●	●	●	●	●	●	●	●	●	●	●	●	●	●	●	●	●	●	●	●	●	●	●
Potassium Permanganate (20%)	●	●	●	●	●	●	●	●	●	●	●	●	●	●	●	●	●	●	●	●	●	●	●	●	●	●	●
Propylene Glycol	●	●	●	●	●	●	●	●	●	●	●	●	●	●	●	●	●	●	●	●	●	●	●	●	●	●	●
Pyridine	●	●	●	●	●	●	●	●	●	●	●	●	●	●	●	●	●	●	●	●	●	●	●	●	●	●	●
Salicylic Acid	●	●	●	●	●	●	●	●	●	●	●	●	●	●	●	●	●	●	●	●	●	●	●	●	●	●	●
Silver Nitrate	●	●	●	●	●	●	●	●	●	●	●	●	●	●	●	●	●	●	●	●	●	●	●	●	●	●	●
Sodium Hydroxide (50%)	●	●	●	●	●	●	●	●	●	●	●	●	●	●	●	●	●	●	●	●	●	●	●	●	●	●	●
Sodium Hypochlorite (20%)	●	●	●	●	●	●	●	●	●	●	●	●	●	●	●	●	●	●	●	●	●	●	●	●	●	●	●
Sodium Thiosulphate	●	●	●	●	●	●	●	●	●	●	●	●	●	●	●	●	●	●	●	●	●	●	●	●	●	●	●
Sulphuric Acid (10%)	●	●	●	●	●	●	●	●	●	●	●	●	●	●	●	●	●	●	●	●	●	●	●	●	●	●	●
Sulphuric Acid (98%)	●	●	●	●	●	●	●	●	●	●	●	●	●	●	●	●	●	●	●	●	●	●	●	●	●	●	●
Tetrahydrofuran	●	●	●	●	●	●	●	●	●	●	●	●	●	●	●	●	●	●	●	●	●	●	●	●	●	●	●
Tetrahydronaphthalene	●	●	●	●	●	●	●	●	●	●	●	●	●	●	●	●	●	●	●	●	●	●	●	●	●	●	●
Thionyl Chloride	●	●	●	●	●	●	●	●	●	●	●	●	●	●	●	●	●	●	●	●	●	●	●	●	●	●	●
Toluene	●	●	●	●	●	●	●	●	●	●	●	●	●	●	●	●	●	●	●	●	●	●	●	●	●	●	●
Trichloroethylene	●	●	●	●	●	●	●	●	●	●	●	●	●	●	●	●	●	●	●	●	●	●	●	●	●	●	●
Turpentine	●	●	●	●	●	●	●	●	●	●	●	●	●	●	●	●	●	●	●	●	●	●	●	●	●	●	●
Vegetable Oil	●	●	●	●	●	●	●	●	●	●	●	●	●	●	●	●	●	●	●	●	●	●	●	●	●	●	●
Xylene	●	●	●	●	●	●	●	●	●	●	●	●	●	●	●	●	●	●	●	●	●	●	●	●	●	●	●

Always test for your own application before selecting the appropriate product.



## Key to Summary Icons

These 'Summary Icons' are intended to give a quick guide to the chemical resistance of the polymers.



Exceptional resistance to almost all laboratory chemicals.



Good to excellent chemical resistance across a broad range of common laboratory chemicals.



Moderate to good resistance to common aqueous laboratory chemicals but avoid organic solvents and strong acids and bases.



Autoclavable.

Note: Where no icon is shown product is manufactured from several materials, refer to text for component's resistance.

Reference to methods of sterilization are based on the following standards:

Autoclaving 121°C, 15 psi for 30 minutes.  
When autoclaving always ensure caps are loosened or removed to prevent accidental implosion. Certain chemicals which have no appreciable effect on resins at room temperature may cause deterioration at autoclaving temperatures unless removed with distilled water before hand.

Gas-Ethylene oxide formaldehyde.

Dry heat 160°C, 120 minutes.

Disinfectants - Benzalkonium chloride, formalin, ethanol, etc.

Radiation - gamma irradiation at 2.5 (Mrad) with unstabilized plastic.

Note: Sterilizing reduces the mechanical strength of certain polymers.

## Low Density Polyethylene (LDPE)

The first of the polyolefins originally prepared some fifty years ago by the high pressure polymerization of ethylene. Its comparatively low density arises from the presence of a small amount of branching in the chain (on about 2% of the carbon atoms). This gives a more open structure. LDPE is a most useful and widely used plastic. It is translucent to opaque, robust enough to be virtually unbreakable and at the same time quite flexible. Chemically LDPE is unreactive at room temperature although it is slowly attacked by strong oxidizing agents and some solvents will cause softening or swelling. It may be used at temperatures up to 95°C for short periods and at 80°C continuously. LDPE is ideally suited for a wide range of laboratory apparatus including wash bottles, pipette washing equipment and tanks.



## High Density Polyethylene (HDPE)

A linear polymer prepared from ethylene by a catalytic process. The absence of branching results in a more closely packed structure with a higher density and somewhat higher chemical resistance than LDPE. It is also somewhat harder and more opaque and it can withstand rather higher temperatures (120°C for short periods, 110°C continuously). It lends itself particularly well to blow moulding, e.g. for bottles and containers.



## Polypropylene (PP)

A polymer prepared catalytically from propylene which differs from HDPE by having an isotactic replacement of a hydrogen atom by a methyl group on alternate carbon atoms in the main chain. Although largely unreactive chemically the presence of the methyl groups makes it slightly more susceptible to attack by strong oxidizing agents than HDPE. A major advantage is its higher temperature resistance. It makes it particularly suitable for items such as trays and instrument jars that have to be sterilized frequently for use in a clinical environment. PP is a translucent material with excellent mechanical properties and it has gradually replaced the polyethylenes for many purposes.



A

## Polymethylpentene (PMP or 'TPX'\*)

A polymer of 4-methylpentene-1 which is similar to PP but has an isobutyl group in place of methyl group on alternate C atoms. The important qualities of PMP ("TPX") as a laboratory plastic are its high transparency, its rigidity and resistance to impact and its ability to withstand temperatures of up to 180°C for short periods (145°C continuously). It is particularly suitable for volumeetric apparatus such as flasks, measuring cylinders and beakers. Like other polyolefins PMP ("TPX") is susceptible to attack by strong oxidizing agents over a period of time and some chlorinated solvents (e.g. trichloroethylene) can cause some softening and swelling. \*"TPX" is a trademark of Mitsui Petrochemicals Ltd.



A

## Polyvinylchloride (PVC)

PVC has a linear structure similar to polyethylene but with a chlorine atom replacing a hydrogen atom on alternate carbon atoms. PVC itself is hard and rigid but the addition of phthalate esters as plasticizers makes it soft and pliable and ideal for tubing. The material is generally transparent with a bluish tint. It is attacked by many organic solvents but it has a very good resistance to oils and it has a low permeability to gases. In its rigid form PVC is available in sheets which can readily be welded to produce tanks, trays and troughs. It is not recommended for use above 70°C although it can be taken to 80°C for short periods.





## Polycarbonate (PC)

PC is a linear polycarbonic acid ester prepared from a dihydric phenol. It possesses extraordinarily good dimensional stability with a high impact strength which is maintained over a wide temperature range. This makes it ideal for the manufacture of laboratory safety shields, vacuum desiccators and centrifuge tubes. PC may be autoclaved (maximum continuous working temperature 130°C, and 140°C for short periods), but some loss in mechanical strength occurs on repeated autoclaving and the equipment should not then be used for vacuum applications. The carbonate linkages in the chain make the material subject to reaction with a variety of concentrated acids and bases and it is soluble in various organic solvents.



143354 Zebrafish Series

## Polystyrene (PS)

A hard rigid, transparent plastic with good dimensional stability. The material has good chemical resistance to many aqueous solutions but it is soluble in many aromatic and halogenated solvents. It cannot be used at elevated temperatures (maximum 60°C continuous, 70°C for short periods) and it tends to suffer from mechanical stress. It finds a wide use in disposable laboratory products. The chemical resistance to non-polar solvents and aromatics can be improved by co-polymerizing styrene with acrylonitrile (CH<sub>2</sub>=CH-CN). The resultant product SAN usually contains 25-35% of acrylonitrile by weight. SAN also has an improved impact strength and rigidity and is much used for injection molded articles such as boxes and food containers. An acrylonitrile-butadiene-styrene (ABS) graft copolymer is obtained by polymerizing acrylonitrile and styrene in the presence of soluble polybutadiene [(CH<sub>2</sub>-CH=CH-2)<sub>n</sub>]. The physical properties of the product may be varied by changing the individual proportions. The polymer has a higher chemical resistance than PS and it will retain its stability of shape up to 100°C.



## Polymethylmethacrylate (ACRYLIC)

A rigid plastic with a high degree of transparency. It is resistant to inorganic acids and alkalis but is attacked by a wide range of organic solvents. Its clarity and stability make it very suitable for the manufacture of burets and in sheet form it may be cemented to produce tanks, trays, etc. ACRYLIC may be used at temperatures up to 70°C continuously and to 90°C for short periods. 10mm thick Acrylic provides an effective barrier to Beta radiation.



## Polytetrafluoroethylene (PTFE)

PTFE shows a remarkable chemical resistance and it is insoluble in all known solvents. It is attacked only by molten alkali metals and by fluorine at high temperatures. PTFE is incombustible and may be used up to 260°C (300°C for short periods). Its coefficient of friction is extremely low and it shows the effect of self lubrication with constant mechanical properties which makes it particularly suitable for bearings, joints, O-rings, stirring bars, etc. It may be shaped by compression and sintering into bottles and beakers where its chemical stability and non-wettability make it suitable for use in extreme circumstances.



## Perfluoroalkoxy PTFE (PFA)

PFA is a copolymer of tetrafluoroethylene (CF<sub>2</sub>=CF<sub>2</sub>) with a perfluoroalkyl vinyl ether [F(CF<sub>2</sub>)<sub>m</sub>CF<sub>2</sub>OCF=CF<sub>2</sub>]. The resultant polymer contains the carbon-fluorine backbone chain typical of PTFE with perfluoroalkoxy side chains. The mechanical, chemical and physical properties are fundamentally attributable to the main chain and the chief effect of the side chains is to control the crystallinity of the polymer. Unlike PTFE the new polymer does not require special fabricating techniques. It has outstanding chemical and solvent resistance over a temperature range even greater than PTFE (p.e. -270° to +260°C). PFA has extremely low absorption and permeability levels even at 200°C which make it very suitable for trace element analysis, isotopic separations, sample digestions and the handling of sensitive biological solutions. The material is translucent but liquid levels can easily be seen. In short PFA approximates closely (and in some cases exceeds) the overall properties of PTFE while offering the flexibility of thermoplastic processing. FEP exhibits similar properties but is also susceptible to attack by concentrated perchloric acid.



## Synthetic rubbers and other O-ring and gasket materials

Synthetic rubbers are based mainly on polymers and co-polymers of butadiene and its derivatives.

**Neoprene:** A polymer of chloroprene (2-chlorobutadiene) i.e. CH<sub>2</sub>=CH-CCl=CH<sub>2</sub>. This material has a better oil resistance than natural rubber. The presence of chlorine deactivates the C-C bond and makes it less susceptible to oxidative attack as well as increasing its resistance to solvents. It has a higher temperature and fire resistance than natural rubber.

**Nitrile Rubber:** A co-polymer of acrylonitrile (CH<sub>2</sub>=CHCN) and butadiene, (CH<sub>2</sub>=CH-CH=CH<sub>2</sub>). It has a good solvent resistance increasing with increasing acrylonitrile. Good for gaskets, oil and petrol hoses.

**Viton A:** A co-polymer of perfluoropropene (CF<sub>3</sub>CF=CF<sub>2</sub>) and vinylidene fluoride (CH<sub>2</sub>=CF<sub>2</sub>). It is resistant to chemical and solvents up to 200°C and is used for O-rings, gaskets and hose linings.

The information contained within this catalog is offered for use by technically qualified personnel at their discretion and risk. All technical statements, information and recommendations contained herein are based on tests and data we believe to be reliable, but the accuracy or completeness thereof is not guaranteed and no warranty of any kind is made with respect thereto. We recommend that users satisfy themselves as to the compatibility between contents and containers or substances and apparatus before use. Dimensions given throughout this catalog are nominal unless otherwise stated. Dynalox reserves the right to alter specifications without notice as part of the company's policy of ongoing product improvement.

## Bag - Baritainer



### Bags LDPE/PP

#### BAGS LDPE .0015" THICK

626785	-0002	-0003
Length inches	4	4
Height inches	6	10
Case Quantity	100	100
Case Price \$	10.08	10.08

626785	-0004	-0005
Length inches	6	6
Height inches	8 1/2	10
Case Quantity	100	100
Case Price \$	11.23	12.25

626785	-0006	--0008	-0009	-0010	-0011
Length inches	6	8	10	10	12
Height inches	12	10 1/2	12	16	18
Case Quantity	100	100	100	100	100
Case Price \$	13.32	13.80	16.77	21.80	22.71

626785	-0013	-0014	-0015
Length inches	16	18	22
Height inches	18	24	28
Case Quantity	100	100	100
Case Price \$	28.80	36.37	47.39

#### BAGS POLYPROPYLENE .0015" THICK

	628505	628515	628525	628535	628545
Length inches	4	4	6	6	10
Height inches	6	10	10	12	16
Case Quantity	100	100	100	100	100
Case Price \$	18.37	24.28	25.73	30.59	40.36

	628555	628565	628575	628585	628595
Length inches	12	12	16	18	22
Height inches	18	24	18	23	30
Case Quantity	100	100	100	100	100
Case Price \$	53.43	59.23	62.85	82.80	122.19



### Heavy Duty Sample Bags - Zipper Seal LDPE

These heavyweight (4 mil & 2 mil) polyethylene bags are ideal for collecting, storing and protecting laboratory specimens and samples easily and conveniently. Sealed bags keep dust out. Not suggested for use with liquids. Many uses in the lab and industry. Bags lock easily and securely with the zipper locking feature. No printing on the bag allows easier labeling and marking.

#### HEAVY DUTY SAMPLE BAGS - ZIPPER SEAL LDPE - 4 MIL. THICK

	628405	628415	628425	628435
Length inches	4	5	6	9
Height inches	6	8	13	12
Case Quantity	500	500	250	250
Case Price \$	135.86	165.62	135.37	160.70

#### ECONOMY SAMPLE BAGS - ZIPPER SEAL LDPE - 2 MIL. THICK

	628325	628335	628345	628355	628365
Length inches	2	3	4	5	9
Height inches	3	5	6	8	12
Case Quantity	1000	1000	1000	1000	1000
Case Price \$	33.19	41.92	52.39	89.98	196.48



### Ties Coated LDPE

Ties are extruded of bright red LDPE bonded to an annealed steel wire on a 4000' spool. Can be cut to any size.

626814 \$123.77 each



### Baritainer® Jerry Cans

- Replaces fluorinated, glass, steel and epoxy phenolic
- UN Classification X Rated (4-10L) Y Rated (13-20L)
- Impact and corrosion resistant
- Durable, lightweight, stackable
- FDA Compliant
- Economical and Recyclable

Baritainer® Jerry Cans with handle (4L, 5L, 10L 13L & 20L) from Dynalon are the alternative solution for packaging, storing & transporting chemicals that usually require glass, metal, fluorinated HDPE or other single barrier containers.

Baritainers are impact resistant, lightweight, rugged, economical & stackable containers for chemicals. Baritainers are effective containers for solvents, esters, ketones and some acids.

405594	-0004	-0001
Capacity gallons (liters)	1.1 (4)	1.32 (5)
Weight lbs (grams)	0.6 (286)	0.6 (272)
A - Length inches (mm)	7.25 (125)	7.5 (190)
B - Width inches (mm)	5.5 (140)	5.7 (145)
C - Height inches (mm)	8.3 (211)	9.2 (235)
D - Height to Handle inches (mm)	8.5 (216)	9.8 (250)
F - Neck inches (mm)	1.6 (41)	1.6 (41)
E - Cap	DIN 50	DIN 50
Price Each US \$	8.06	10.81

405594	-0002	-2070
Capacity gallons (liters)	2.64 (10)	5.28 (20)
Weight lbs (grams)	1.3 (590)	2.65 (1202)
A - Length inches (mm)	8.75 (222)	10.1 (265)
B - Width inches (mm)	7.25 (184)	10.9 (277)
C - Height inches (mm)	12.0 (305)	14.3 (363)
D - Height to Handle inches (mm)	12.5 (318)	14.7 (374)
F - Neck inches (mm)	1.6 (41)	2.755 (70)
E - Cap	DIN 50	70mm
Price Each \$	16.38	29.96



Further Baritainer information and accessories on page 34.



522085 Polypropylene Series

Azlon



522095 Polymethylpentene Series

**“Square Ratio” Design Printed Polypropylene and Polymethylpentene Beakers**

- Shatter resistant - reduce breakage & incidence of injury!
- Chemically resistant to most acids, bases and many common solvents
- Autoclavable
- Choose glass-like clarity of polymethylpentene (PMP) or
- Choose economical translucent polypropylene (PP)

Square ratio beakers are the safe, convenient alternative to griffin style beakers. These beakers feature a vertical lip around the top of the beaker which serves two purposes: first the lip contains many spills that may occur with the rounded design of a griffin style beaker. Second, this vertical lip allows the beakers to be stacked together in sets when not in use. Maximum temperature for PP is 135°C; PMP is 150°C to 180°C for short intervals.

**PRINTED IN BLUE PP “SQUARE RATIO” BEAKERS**

522085	-0010	-0025	-0050	-0100	-0250
Capacity ml	10	25	50	100	250
Sub Div. ml	1	2.5	5	10	25
I.D. mm	30	40	49	60	80
O.D. mm	32	42	51	62	82
Height mm	32	40	51	62	82
Pack Qty.	10	10	10	10	10
Pack Price \$	22.53	19.86	23.42	26.93	46.04

522085	-0400	-0500	-0600	-1000	-2000
Capacity ml	400	500	600	1000	2000
Sub Div. ml	50	50	50	100	200
I.D. mm	92	96	101	123	154
O.D. mm	94	100	106	127	158
Height mm	95	101	107	126	160
Pack Qty.	10	10	5	5	1
Pack Price \$	46.04	54.59	23.87	34.31	10.50

**PRINTED IN RED PMP “SQUARE RATIO” BEAKERS**

522095	-0025	-0100	-0250	-0400
Capacity ml	25	100	250	400
Sub Div. ml	2.5	10	25	50
I.D. mm	40	60	80	92
O.D. mm	42	62	82	94
Height mm	40	62	82	95
Case Qty.	10	10	5	5
Case Price \$	48.91	58.41	43.48	46.70

522095	-0500	-0600	-1000	-2000
Capacity ml	500	600	1000	2000
Sub Div. ml	50	50	100	200
I.D. mm	96	101	123	154
O.D. mm	100	106	127	158
Height mm	101	107	126	160
Case Qty.	5	5	1	1
Case Price \$	53.40	58.15	17.17	20.14

**POLYPROPYLENE BEAKER SETS**

	522125	522135-0001
Capacity	10 sizes above	50, 100, 250, 500 & 1000ml
Set Price \$	46.00	22.66

	522135-0002	522135-0003
Capacity	50, 100, 250, 600 & 1000ml	250, 500 & 1000ml
Set Price \$	22.67	17.39



See beaker bars on page 88



**Beakers HDPE**

- Extra heavy wall
- Low Form

Molded of FDA Approved high density polyethylene resin. These heavy walled graduated beakers are slightly tapered to allow nesting. Each beaker features two properly formed spouts which assist in pouring and preventing dripping.

312004	-0050	-0100	-0250	-0600	-1000
Capacity ml	50	100	250	500	1000
Inner Diam. mm	41	51	76	95	114
Height mm	54	70	76	102	127
Pack Qty.	4	4	2	1	1
Pack Price \$	29.21	34.08	19.29	12.73	16.29

# Beaker



**522055 Polypropylene Series**



**522765 Polymethylpentene Series**

*Azlon*

## Tapered Low-Form Polypropylene & Polymethylpentene Beakers

- Shatter resistant - reduce breakage & incidence of injury!
- Chemically resistant to most acids, bases and many common solvents
- Beakers are not calibrated
- Autoclavable
- Choose glass-like clarity of polymethylpentene (PMP) or
- Choose economical translucent polypropylene (PP)
- Comply with ISO7056

Introducing the latest addition to the Azlon family of high quality durable plastic labware - smoothly tapered beakers made from virgin, high clarity polypropylene or transparent polymethylpentene. Available with both molded and easy to read blue printed graduations. This extensive range of beakers from 25ml to 5 liters is break resistant and durable. Also supplied with an anti-lock feature that prevents beakers from sticking together when stacked. Tapered design allows for easy handling. SPI recycling codes and batch stamped for full traceability. Maximum temperature for PP is 121°C; PMP is 180°C.

### MOLDED POLYPROPYLENE LOW FORM BEAKERS

522055	-0025	-0050	-0100	-0250	-0400	-0500
Capacity ml	25	50	100	250	400	500
Sub Div. ml	5	10	20	50	50	50
Height mm	51	61	73	96	111	121
Base O.D. mm	32	39	48.5	65.5	74.5	84
Rim Diam. mm	41.5	50.5	61.5	80.5	92.5	102.5
Pack Qty.	10	10	10	10	10	10
Pack Price \$	17.32	18.07	18.77	30.84	43.48	47.98

### MOLDED POLYPROPYLENE LOW FORM BEAKERS

522055	-0600	-1000	-2000	-3000	-5000
Capacity ml	600	1000	2000	3000	5000
Sub Div. ml	50	100	200	200	500
Height mm	126	148	188	214	250
Base O.D. mm	84	99	125	143	164
Rim Diam. mm	104	120	163	172	230
Pack Qty.	5	5	1	1	1
Pack Price \$	27.87	70.25	17.22	19.55	28.76

### PRINTED POLYPROPYLENE LOW FORM BEAKERS

522655	-0025	-0050	-0100	-0250	-0400	-0500
Capacity ml	25	50	100	250	400	500
Sub Div. ml	5	10	20	50	50	50
Height mm	51	61	73	96	111	121
Base O.D. mm	32	39	48.5	65.5	74.5	84
Rim Diam. mm	41.5	50.5	61.5	80.5	92.5	102.5
Pack Qty.	10	10	10	10	10	10
Pack Price \$	28.86	31.36	33.36	42.17	62.34	70.18

### PRINTED POLYPROPYLENE LOW FORM BEAKERS

522655	-0600	-1000	-2000	-3000	-5000
Capacity ml	600	1000	2000	3000	5000
Sub Div. ml	50	100	200	200	500
Height mm	126	148	188	214	250
Base O.D. mm	84	99	125	143	164
Rim Diam. mm	104	120	163	172	230
Pack Qty.	5	5	1	1	1
Pack Price \$	38.16	56.96	24.28	20.24	48.95

### PRINTED POLYMETHYLENTPENTENE LOW FORM BEAKERS

522765	-0025	-0050	-0100	-0250
Capacity ml	25	50	100	250
Sub Div. ml	5	10	20	50
Height mm	51	61	73	96
Base O.D. mm	32	39	48.5	65.5
Rim Diam. mm	41.5	50.5	61.5	80.5
Pack Qty.	10	10	10	5
Pack Price \$	49.63	58.63	58.93	38.63

### 522765

522765	-0400	-0500	-0600	-1000
Capacity ml	400	500	600	1000
Sub Div. ml	50	50	50	100
Height mm	111	121	126	148
Base O.D. mm	74.5	84	84	99
Rim Diam. mm	92.5	102.5	104	120
Pack Qty.	5	5	5	1
Pack Price \$	53.27	58.01	64.08	18.80

### 522765

522765	-2000	-3000	-5000
Capacity ml	2000	3000	5000
Sub Div. ml	200	200	500
Height mm	188	214	250
Base O.D. mm	125	143	164
Rim Diam. mm	163	172	230
Pack Qty.	1	1	1
Pack Price \$	38.88	41.99	58.92

### Beakers PTFE

- Optional watch glass available
- Not graduated

Isostatically molded from virgin PTFE and machine finished to give a smooth surface for ease of cleaning and to eliminate contamination. Beakers with pouring spouts are virtually immune to chemical attack, only attacked by some fluorine containing compounds at very high temperature and molten alkalis metals. Working temperature range is from cryogenic to 260°C.



222075 Polypropylene Series



222045 Polymethylpentene Series

**Kartell**

**Griffin Style Beakers - Comply with ISO 7056**

- Special no-drip pouring spout
- Chemically resistant to most acids, bases and many common solvents
- Shatter resistant - reduce breakage & incidence of injury!
- Autoclavable

For general laboratory use. Polypropylene beakers will withstand temperatures up to 135°C and polymethylpentene beakers can withstand temperatures as high as 180°C for short intervals. Graduations molded in milliliters. Conforms to ISO7056.

**MOLDED POLYPROPYLENE GRIFFIN STYLE BEAKERS**

222075	-0050	-0100	-0250	-0500	-1000	-2000	-5000
Capacity ml	50	100	250	500	1000	2000	5000
Sub Div. ml	2	5	10	10	20	50	500
Tolerance +/-	10%	10%	10%	10%	10%	10%	10%
Diameter mm	41	51	71	87	109	132	188.5
Height mm	60	72	95	119	147	183.5	229
Wall Thick mm	1.3	1.5	1.7	1.8	1.8	1.8	2.5
Case Qty.	40	48	40	36	12	4	4
Case Price \$	83.52	111.89	112.80	200.39	104.11	69.21	148.89

**BEAKER SETS**

	222195
Material	Polypropylene
Capacity	50, 100, 250, 500, 1000ml
Set Price \$	21.25
	222205
Material	Polymethylpentene
Capacity	50, 100, 250, 500, 1000ml
Set Price \$	43.95

**MOLDED POLYMETHYLPENTENE GRIFFIN STYLE BEAKERS**

222045	-0050	-0100	-0250	-0500	-1000	-2000
Capacity ml	50	100	250	500	1000	2000
Sub Div. ml	2	5	10	10	20	50
Tolerance +/-	10%	10%	10%	10%	10%	10%
Diameter mm	42	52	71	88	110	133
Height mm	60	72	95	119	146	184
Wall Thick mm	1.3	1.5	1.7	1.8	1.8	1.8
Case Qty.	40	48	40	36	12	4
Case Price \$	167.09	204.37	285.44	401.93	186.14	107.11



See beaker bars on page 88

**PTFE BEAKERS**

	312284	312294	312024	312034	312044	312054	312064
Capacity ml	1	5	10	25	50	100	250
Height mm	18	26	33	47	60	68	97
Diameter mm	13	20	24	32	43	54	66
Price Each \$	11.36	14.26	15.95	18.82	20.73	26.33	53.94
	312084	312074	312094	312174	312184	312244	
Capacity ml	400	500	600	1000	2000	5000	
Height mm	106	125	125	155	210	280	
Diameter mm	80	80	90	100	120	170	
Price Each \$	69.84	77.44	102.09	175.79	274.98	997.74	



**PTFE WATCH GLASS COVERS**

	315294	315304	315314	315324	315334	315384	315344	315354	315374
Fits Beaker ml	1	5-10	25	50	100	250	400-500	600-1000	2000
Diameter mm	20	30	40	50	65	80	100	125	150
Price Each \$	6.47	6.86	8.65	9.30	12.26	13.33	16.72	23.21	43.72

## Beaker - Beaker with Handle



### Heatable Beakers, PTFE Fluoropolymer

- Totally chemical resistant and inert PTFE beaker
- Use to 270°C without distortion
- For use w/ Hydrofluoric Acid and caustic chemicals
- Even heat transfer

This product features the unique combination of a pure PTFE body with a specially formulated stabilized PTFE Carbon base as a single molding allowing for heating to 270°C without distortion.

315284	-0100	-0250	-0400
Capacity ml	100	250	400
Height mm	74	94	112
Diameter mm	56	75	85
Price Each \$	48.46	62.23	96.85



### Tall Form Beaker with Handle PP

High form graduated beakers made of transparent and autoclavable polypropylene. Autoclavable; use up to 135°C.

326485	-0050	-0100	-0250	-0500	-1000
Capacity ml	50	100	250	500	1000
Sub Div. ml	2	2	5	10	20
Top Diameter mm	40	50	74	92	117
Height mm	70	80	120	140	181
Case Qty.	24	24	24	24	24
Case Price \$	56.70	68.01	182.71	186.94	212.40



### Beaker with Handle - Intermediate Form PP

- Tapered jugs in high clarity polypropylene
- Crisp blue printed graduations
- Ergonomically designed handle with thumb grip for easy carrying
- Autoclavable; use up to 135°C

526475	-0050	-0250	-0500	-1000	-2000
Capacity ml	50	250	500	1000	2000
Sub Div. ml	10	50	50	100	100
Top Diameter mm	50	90	102	122	151
Height mm	60	100	120	150	187
Pack Qty.	5	1	1	1	1
Pack Price \$	29.83	8.80	9.66	11.42	14.04

526475	-3000	-5000
Capacity ml	3000	5000
Sub Div. ml	200	200
Top Diameter mm	172	199
Height mm	215	253
Pack Qty.	1	1
Pack Price \$	16.33	47.42

*Azlon*



### Low Form Beaker with Handle PP

- Molded graduations - in liters
- Autoclavable; use up to 135°C
- Low form for added stability

Autoclavable, highly translucent especially when filled with liquids. Permanent molded in graduations. Resistant. No drip spout. Thumb grip on handle.

326495	-0500	-1000	-2000	-3000	-5000
Capacity ml	500	1000	2000	3000	5000
Sub Div. ml	25	50	50	100	250
Top Diameter mm	90	116	145	165	190
Height mm	116	131	165	180	225
Pack Qty.	24	24	12	12	12
Pack Price \$	183.30	188.97	106.41	154.02	470.68

**Kartell**

## Beta Radiation Protection Claims

All Dynalon Beta protection products are manufactured using Acrylic sheet certified by an independent organization to be 100% effective in shielding against beta radiation.

For more information please call, fax or write:

Dynalon Technical Service  
175 Humboldt St. Suite 300 Rochester, NY 14610 USA  
Tel: 800-334-7585 Fax: 585-334-0241



### Liquid Waste Storage Box with Cover

Waste box designed to accommodate the included 1 gallon jug. (608715 Jug page 21) The opening in the lid will accept the included wide mouth funnel (241725 Funnel page 60) for easy disposal of liquid radioactive material. Excess residue can be rinsed from the funnel into jug to further reduce exposure. Supplied with non-skid feet, jug and funnel. Internal dimensions: 6 1/2" L x 6 1/2" W x 12" H. Additional sizes available upon request.

172085 Liquid Waste Box with Cover \$204.75 each



### Liquid Waste Storage Box, Enclosed Model

Similar to Catalog Number 172085 above, but taller to hold the included bottle and funnel inside the unit. Hinged cover. Supplied with non-skid feet, jug and funnel. Unit measures 6 1/2" L x 6 1/2" W x 18 1/2" H ID. Additional sizes available upon request.

172095 Liquid Waste Box, Enclosed Model \$309.74 each

**SEE  
included 1 gallon  
jugs on page 21  
  
included funnels  
on page 60**



### Beta Storage Cabinet

- Locking
- Four adjustable shelves
- Leveling feet
- Beta warning stickers

Locking beta storage cabinet is available with four adjustable shelves allowing for secure storage of your beta samples. Cabinet features space saver design to fit nicely on most bench tops. Shelves are sized to accommodate racks, bottles, boxes, etc... Unit has four adjustable leveling feet and safety lock. Supplied with radiation hazard stickers. Dimensions: 12" L x 30" W x 24" H. Additional sizes available upon request.

172034 Beta Storage Cabinet \$654.24 each

**MADE IN**  
  
**U. S. A.**



### Beta Storage Box with Foam Rack

This box features a disposable foam insert to accommodate various small bottles. Box is supplied with non-skid feet and radiation hazard warning labels. Dimensions: 3 1/8" H x 11" L x 7 7/8" W. Additional sizes available upon request.

172634 Beta Storage Box with Foam Rack \$166.26 each

All Beta products protect against <sup>3</sup>H, <sup>14</sup>C and <sup>35</sup>S and are supplied with Beta warning sticker you apply.

## Beta Radiation Protection



### Beta Storage Box with Hinged Lid

Beta shielding box is for storage of a wide variety of laboratory products. Available in many sizes to suit almost every need. 100% shielding from <sup>32</sup>P emitters. Hinged lid for easy handling. All supplied with non-skid feet and radiation hazard labels. All dimensions are internal (ID). [Additional sizes available upon request.](#)

	172105	172654	172664	172684
Description	Slim	Desktop	Bin	Mini
Length inches	4	6	8	2 1/2
Width inches	8	6	8	6 1/2
Height inches	15 1/2	6	10	3 3/8
Price Each \$	260.13	123.98	156.84	94.83

### RACKS FOR 172684 BETA STORAGE BOX

	172694	172704	172714
Holds Tubes mL	0.5	1.5	2.0
Tube Quantity	32 place	32 place	32 place
Height inches	2	2	2
Length inches	6 1/4	6 1/4	6 1/4
Width inches	3 1/4	3 1/4	3 1/4
Price Each \$	34.62	34.62	34.62

**See liner bags for floor bins on page 8**



172125

### Floor Bin with Lid



172125-0001

Extra large capacity storage bins hold carboys, linens, bench liners, etc. 172125 is supplied with non-skid feet. 172125-0001 is supplied with acrylic carpet skids so it slides easily under work bench. Removable lid allows for use with liner bags. 172125 is supplied with one liner bag (626785-0015 page 8) and both include radiation warning labels. [Additional sizes available upon request.](#)

172125	Floor Bin 13"D x 9"W x 15"H	\$435.33 each
172125-0001	Floor Bin 12"D x 12"W x 24"H	\$543.37 each



### Beta Storage Box with Hinged Lid

Beta shielding box is for storage of a wide variety of laboratory products. 100% shielding from <sup>32</sup>P emitters. Hinged lid for easy handling. Supplied with non-skid feet, one blue microcentrifuge tube rack (225675-

0002 on page 97) and radiation hazard labels. Internal Dimensions: (L x W x H): 10 3/4 x 4 3/4 x 3". [Additional sizes available upon request.](#)

172684-0001

Beta Storage Box with Rack

\$94.84 each

**See cleaning notes on page 16.**



172624



172125-0002

### Mobile Floor Bin

Extra large capacity storage bins hold carboys, linens, bench liners, etc. Units come with four heavy duty casters for complete portability. Full shielding from Beta emitters keeps personnel safe during transports. Supplied complete with radiating warning labels. [Additional sizes available upon request.](#)

	172125-0002*
Description	Box with removable lid
Depth inches	12
Width inches	12
Height inches	24
Price Each \$	638.63

	172134	172624
Description	Box with hinged lid	Box with hinged lid
Depth inches	20	12
Width inches	20	12
Height inches	28	24
Price Each \$	817.05	545.27

\*172125-0002 supplied with one liner bag (626785-0015 page 8).

All Beta products protect against <sup>3</sup>H, <sup>14</sup>C and <sup>35</sup>S and are supplied with Beta warning sticker you apply.





### Beta Storage Box with Lid

Allows for safe storage of various racks, reagent bottles, and other vessels containing Beta-emitting isotopes. Safely guards against exposure to  $^3\text{H}$ ,  $^{14}\text{C}$ ,  $^{35}\text{S}$  and  $^{32}\text{P}$ . Cover has handle. Supplied with non-skid feet and radiation hazard labels. Additional sizes available upon request.

172145

	172005	172145
Description	Removable lid	Removable lid
Length inches	9	6
Width inches	6	6
Height inches	7	6
Price Each \$	147.97	116.47



### Beta Blocks with Base and Cover

Heavy solid acrylic blocks hold four, twelve or twenty-four 1.5ml microcentrifuge tubes. Designed for both bench-top work as well as long term storage of beta-emitting radioactive isotope samples. Supplied with cover,

172644

non-skid feet and radiation hazard warning labels. Additional sizes available upon request.

	172334	172344	172644
Description	4 place	12 place	24 place
Fits Tubes ml	1.5	1.5	1.5
Length inches	4 3/4	7 1/2	7 1/2
Width inches	2 1/4	2 3/4	5 1/2
Height inches	2 3/4	3 1/2	3
Price Each \$	112.57	180.37	155.00



See tips on page 73 tubes on page 95

### Tip and Tube Beta Storage Box

This storage box has a special opening in lid for disposal of contaminated pipette tips and/or tubes. Box is supplied with non-skid feet and radiation hazard warning labels. Dimensions: 6"H x 6"L x 6"W. Additional sizes available upon request.

172674

Tip and Tube Beta Storage Box

\$94.83 each



All Beta Protection Products are fabricated in our Rochester, NY facility and can be customized to your special requirements.

## Sample Storage Box

Allows for safe and easy storage and transport of samples. Removable shelves and racks are available in many sizes to accommodate different microcentrifuge tubes. Units are designed to allow icing of samples if desired. Supplied with non-skid feet and radiation hazard labels. Additional sizes available upon request.

### SAMPLE BOX - 36 PLACE

172185	-0000	-0001	-0002	-0003	-0004	-0005	-0006	-0007
Description	Box/Shelf	Box/Shelf	Box/Shelf	Shelf	Shelf	Shelf	Shelf	Shelf
Fits Tubes ml	1.5	0.5	2.5	1.5	0.5	2.5	0.75	1.0
Length inches	8	8	8	8	8	8	8	8
Width inches	4	4	4	4	4	4	4	4
Height inches	2 1/4	2 1/4	2 1/4	N/A	N/A	N/A	N/A	N/A
Price Each \$	116.41	148.96	148.96	36.05	36.05	36.05	36.05	36.05



172165-0004

### SAMPLE BOX - 48 PLACE

172165	-0000	-0001	-0002	-0003	-0004	-0005
Description	Box/Shelf	Shelf	Shelf	Shelf	Shelf	Shelf
Fits Tubes ml	1.5	0.5	0.75	1.0	1.5	2.5
Length inches	10	10	10	10	10	10
Width inches	5 1/4	5 1/4	5 1/4	5 1/4	5 1/4	5 1/4
Height inches	3	N/A	N/A	N/A	N/A	N/A
Price Each \$	183.25	36.77	36.77	36.77	36.77	36.77



172165-0000

All Beta products protect against  $^3\text{H}$ ,  $^{14}\text{C}$  and  $^{35}\text{S}$  and are supplied with Beta warning sticker you apply.

# Beta Radiation Protection



172324-0000

### Enclosed Enzyme Freezer Box

Designed for storage of vials or microcentrifuge tubes in cold temperatures, the back of the box slides open to allow for insertion of Gel Ice packs. Specifically designed for safe storage.

Dimensions for 100 place rack with 7/16" (1.1 cm) holes: ID 10 5/8" L x 8 5/8" W x 3 1/2" H. 200 place rack with 7/16" (1.1 cm) holes: ID 16" L x 11" W x 5" H. Additional sizes available upon request.

172324-0000	Enclosed Freezer Box - 100 Place	\$324.75 each
172324-0001	Enclosed Freezer Box - 200 Place	\$608.12 each



*All Beta Protection Products are fabricated in our Rochester, New York facility and can be customized to your special requirements.*



### Bench Top Splash and Beta Shields

- No eye-level distortion
- Extra wide top
- Non-skid feet
- Beta warning stickers

Lower bend and wider top gives greater visibility of work surface and assures greater protection from splashes to face and neck area. The Splash Shield has been designed to be used comfortably either from a standing or sitting position. The gentle bend from the base allows the technician to observe the working surface from a comfortable sitting position. The lower area of the Shield is just 12" wide, thus making it easy to reach behind the Shield to pipette, open vials or perform any number of functions, while protecting the operator from being accidentally splashed. Fabricated from 3/8" clear acrylic for excellent stability. Non-skid feet. Measurements: base—20" W x 12" D; face area—20" W x 15" H; overall—20" W x 12" D x 20" H. Additional sizes available upon request.

## Important - Cleaning Note

Should the acrylic surfaces of acrylic products need cleaning, DO NOT USE ANY SOLVENTS OR ABRASIVES (alcohol, acetone, etc...)

USE OF THESE MATERIALS WILL CAUSE CRACKING OR CRAZING OF THE ACRYLIC.

For general cleaning wash the surface with a mild detergent and soft cloth, then rinse thoroughly with clean water.

	172274	172284*
Description	Beta Particle	Biohazard Splash
Thickness inches	3/8	1/4
Width inches	20	20
Height inches	20	20
Depth inches	12	12
Price Each \$	127.70	104.86

\*Not suitable for radiation protection.

### Bench Top Beta Shields

- High quality shields in 3/8 inch Acrylic protect against beta radiation
- Angles allow comfortable ergonomic working position when examining or handling samples
- Excellent demonstration shield
- Biohazard shield for blood-borne pathogens

Bench top shields are designed with the safety of the user in mind. The top is angled and wide to protect the face and body. Like our popular Splash Shield, the user can easily place his / her arms around the shields to perform any number of procedures while still protecting the operator. Additional sizes available upon request.

	172254	-0000	172604	172614	172294	172304
Bend Description	Single	Single	Dual	Dual	Dual	Dual
Width inches	12	12	12	9	12	12
Height inches	12	18	18	15	20	20
Depth inches	4	6	6	8	10	10
Price Each \$	50.59	70.96	70.96	82.79	95.92	95.92



172254-0000

172294

## Beta Radiation Protection - Bottle, Dispensing



### Hinged Beta Shield

Versatile 3/8" full gauge acrylic Beta shield provides enclosed three sided stand alone protection as well as convenient fold-away storage. May also be used as U-shaped shield. Combine with our Catalog Number 172304 on page 16 to create a full four sided enclosure. Dimensions: 16 1/2"H with 14" front and 12" sides. [Additional sizes available upon request.](#)

172384 Hinged Beta Shield \$197.12 each



### U-Form Radiation Shields

These U-Form Radiation Safety Shields are made of 3/8" full gauge acrylic. Shields protect against P<sup>32</sup>, C<sup>14</sup>, and S<sup>35</sup>. Dimensions: 24"H with 20" front and 9" sides. [Additional sizes available upon request.](#)

172355 U-Form Beta Shield \$195.55 each



### Round Eye Dropper LDPE *Azlon*

A 15 ml dropper bottle with a fine bore neck insert and specially shaped polyethylene cap. Available in natural or amber polyethylene. Supplied capped in shrink-wrapped packs. Maximum temperature for LDPE is 80°C.

524195	-0001	-0002
Capacity ml	15	15
Description	Natural	Amber
Diameter mm	24	24
Height mm	74	74
Case Quantity	10	10
Case Price \$	20.59	24.20



### Bottles, Dropping PTFE

Heavy wall, wide mouth PTFE screw closure with machine finish for ease in cleaning. Virtually immune to chemical attack, only attacked by some fluorine containing compounds at high temperature and molten alkalis metals. Working temperature range is from cryogenic to 260°C. Non-sticking.

305034	-0025	-0050
Capacity ml	25	50
Height mm	80	100
Diameter mm	33	43
Price Each \$	77.45	86.68



### Plunger Dispensing Bottle HDPE

Standard plunger dispenses 1 fluid ounce per stroke. Dispenser can be taken apart for cleaning. Excellent for use with food products, cleaners, waxes and hand soaps. Can be used with inorganic salt solutions, alkalies, low K.B. solvents, and mineral, vegetable or animal oils. Supplied with 1 gallon HDPE jug.

605074	
Capacity gallons	1
Height mm	300
Diameter mm	155
Case Quantity	12
Case Price \$	125.17



### Dispensing Bottle 500mL HDPE

**Kartell**

Supplied with Polypropylene closure, this 500mL dispensing bottle is highly suitable for dispensing liquids and creams. Wide surface area is easily labeled with contents. Suitable for food grade products.

205135 \$32.08 case of 5

# Bottle, Dispensing



Sealer

Dropping

Ribbon

Bellows

These low density polyethylene bottles are supplied with a variety of closures to suit any dispensing application. Maximum temperature for LDPE is 80°C.

### LDPE SEALER CAP BOTTLES (LDPE closure and red nozzle cap)

605085	-0005	-01	-02	-04	-06	-08	-16
Capacity ml	15	30	60	125	180	250	500
Height w/ cap mm	36	98	108	144	162	174	195
Bottle Diameter mm	24	30	36	47	55	60	79
Cap Size mm	15	18	18	24	24	24	28
Pack Quantity	12	12	12	12	12	12	12
Case Quantity	48	48	48	36	36	36	24
Case Price \$	50.06	52.66	61.74	61.74	78.93	91.06	77.40

### LDPE DROPPING BOTTLES

605065	-0005*	-0010	-0020	-0040	-0060	-0080	-0160
Capacity ml	15	30	60	125	180	250	500
Height w/ cap mm	77	81	91	115	132	144	167
Bottle Diameter mm	24	30	36	47	55	60	79
Cap Size mm	15	18	18	24	24	24	28
Pack Quantity	12	12	12	12	12	12	12
Case Quantity	48	48	36	36	36	24	24
Case Price \$	86.59	110.43	99.00	107.15	122.79	99.70	134.11

\*15mL supplied with 2 piece cap as shown in photo below .

### LDPE RIBBON SPREAD BOTTLES

604085	-04	-06	-08	-16
Capacity ml	125	180	250	500
Height w/ cap mm	147	164	176	195
Bottle Diameter mm	47	55	60	79
Cap Size mm	24	24	24	28
Pack Quantity	12	12	12	12
Case Quantity	36	36	36	24
Case Price \$	66.86	74.26	84.83	77.24

### LDPE BELLOWS DROPPING BOTTLES

224155	-01	-02	-04	-08
Capacity ml	30	60	125	250
Height w/ cap mm	135	135	196	196
Bottle Diameter mm	32	40	50	60
Cap Size mm	22	22	28	28
Pack Quantity	12	12	12	12
Case Quantity	48	48	48	36
Case Price \$	145.92	160.30	257.93	217.04

605065-0005



### Dispensing Bottles with Nozzle LDPE

- Leakproof screw closure
- Flexible

The white polyethylene screw cap has a pivoting nozzle which can be raised to give a direct jet of liquid as the bottle is squeezed. When the nozzle is closed the passage for liquid is shut off to give an airtight seal at normal pressure, although when the nozzle is partly open it makes an excellent dropping device. Max. temperature for LDPE is 80°C.

524165	-0030	-0060	-0150	-0250	-0500
Capacity ml	30	60	150	250	500
Height mm	84	97	120	150	170
Bottle O.D. mm	31	39	59	59	74
Case Quantity	10	10	10	10	10
Case Price \$	19.82	21.07	21.98	25.75	31.51

*Azlon*



### Dispensing Bottles with Attached Cap LDPE

- Attached cap

A low density bottle with polyethylene dropper closure with captive cap. Supplied capped in shrink-wrapped packs of ten. Max. temperature for LDPE is 80°C.

524185	-0030	-0060	-0125	-0250	-0500
Capacity ml	30	60	150	250	500
Diameter mm	31	39	50	59	74
Height mm	115	128	144	176	196
Case Quantity	10	10	10	10	10
Case Price \$	13.09	12.86	14.75	22.04	27.93

*Azlon*

**NEW Flip & Spray™ Bottle PE/PP**

*The spray bottle that even works upside down!*

- Uninterrupted spraying
- Parts in contact with media made of PP, PE, silicon and stainless steel
- Nozzle diameter 0.6 mm and continuously adjustable
- Amount sprayed per stroke: 1.2 ml ± 0.1

These unique 250, 500 and 1000mL reusable polyethylene Spray Bottles with a polypropylene sprayer have excellent chemical resistance and will perform upright or inverted. The limber silicone tubing attached to a stainless steel weight with a PP filter remains immersed in the liquid in the upside down position and allows the product to work. This unique feature lets a user spray conveniently from any direction while reaching many inaccessible areas. Adjust the spray knob to obtain a fine mist to a steady stream.

805104	-0250	-0500	-1000
Bottle Capacity mL	250	500	1000
Height w Closure mm	220	240	295
Neck ID mm	18	18	17.5
Price Each \$	16.03	17.50	18.42



**Dispenser Bottle w/ Adjustable Volume LDPE/PMP**

**Kartell**

The graduated clear PMP measuring cup slides up and down on the vertical polyethylene tube for easy adjustment. The variation in height determines the volume to be dispensed. The cup is filled by squeezing the LDPE bottle and forcing the liquid up the tube. When the bottle pressure is released, the excess will be drawn back into the bottle and only the desired volume will remain.

	206305	206315	206325	206335	206345	206355
Bottle Size ml	250	500	1000	250	500	1000
Bottle Diameter mm	60	75	94	60	75	94
Cup Size ml	5-25	5-25	5-25	5-50	5-50	5-50
Height mm	282	324	354	298	340	370
Case Quantity	10	10	10	10	10	10
Case Price \$	143.26	157.17	201.89	182.55	193.11	242.24



**Dispensing Bottle LDPE**

Tall-style one liter cylindrical bottle supplied with spout and sealer caps. Sealer snaps on easily for tight seal. Spout openings are standard .030" and can be enlarged by cutting tip. Maximum temperature for LDPE is 80°C.

605124 \$42.84 PK/12



**Dropping Bottles, Long and Short Spout LDPE**

**Kartell**

- Low Density Polyethylene bottle with closure / spout
- Choice of 50 or 100mL capacities

An ideal bottle for water and oils - there are no shoulders to restrict the flow. Graduated and can be secured using shoulder and cap tag to avoid sample contamination in transit. Conforms to DIN 13316 and 168. Supplied with LDPE cap for tip closure.

	224125		224135	
	-0050	-0100	-0050	-0100
Spout Length	Long	Long	Short	Short
Volume mL	50	100	50	100
Graduations	10	20	10	20
O.D. mm	38	48	38	48
Height w/ Spout mm	130	146	106	127
Mouth ID mm	13	13	13	13
Pack Quantity	10	10	10	10
Pack Price \$	38.54	44.93	38.54	44.93

**Quick Mist™ Dispenser Bottle HDPE**

- Excellent for spraying all types of thin liquids
- Fine mist with large pattern
- Not suitable for use with food products

Reusable hand sprayer. Trigger-type operation to provide fine mist with large pattern. Trigger assembly chemically resistant polypropylene with plastic strainer. Easily cleaned valve and intake. Excellent for spraying all types of thin liquids. Not suitable for use with food products.



	605144	605154
Capacity ml	500	1000
Height inches	7 7/8	9 25/64
Diameter inches	2 27/64	3 7/16
Pack Quantity	24	24
Pack Price \$	166.76	205.66

## Bottle, General Purpose



### Narrow Mouth Bottle LDPE

This bottle is supplied with polypropylene screw closures. Unbreakable, convenient design. For storage, packaging and other uses. Maximum temperature for LDPE is 80°C.

605005	-05	-04	-06	-08	-16
Capacity ml	15	125	180	250	500
Height mm	68	124	129	141	158
Diameter mm	24	47	55	60	79
Cap Size mm	15	24	24	24	28
Pack Quantity	12	12	12	12	12
Case Quantity	72	72	72	72	48
Case Price \$	78.70	126.65	136.62	135.01	120.06



### Large Bottles LDPE

Large narrow mouth bottle made of low density polyethylene. Excellent chemical resistance. Heavy wall thickness for durability, yet a fraction of the weight of glass. Maximum temperature of LDPE is 80°C.

608573	-0005	-0010	-0020
Capacity Gallons	1/2	1	2
Height mm	274	355	406
Bottle O.D. mm	114	152	190
Cap Size mm	28	38	53
Case Quantity	6	6	6
Case Price \$	124.25	217.60	354.37



### Butress Closure Bottles LDPE

Polyethylene bottles, narrow mouth with a polyethylene butress closures. Maximum temperature of LDPE is 80°C.

605015	-16	-32
Capacity ml	500	1000
Height mm	185	225
Bottle O.D. mm	89	94
Neck I.D. mm	25	25
Cap Size mm	38	38
Pack Quantity	12	12
Case Quantity	48	24
Case Price \$	179.21	130.73



### Economy Bottles HDPE

These general purpose bottles are leakproof, and very economical. Closure is made of LDPE. Maximum temperature for HDPE 110°C and 80°C for LDPE closure.

606215	-0016	-0032
Capacity ml	500	1000
Height mm	156	181
Diameter mm	70	89
Closure mm	53	63
Pack Quantity	12	6
Case Quantity	48	24
Case Price \$	132.70	93.60

## Bottle, General Purpose

NEW



### Polypropylene Graduated Bottles

Azlon

- High performance polypropylene bottles ideal for a wide range of liquids and solids
- Autoclavable polypropylene leak proof construction
- Full range of sizes with high chemical resistance
- Autoclavable; use up to 135°C
- Printed with large white marker space for clear, easy and safe labeling
- Wide mouth for easy access filling
- Clear, crisp printed graduations show milliliters and fluid ounces, allowing estimation of volumes remaining and / or decanted
- High clarity polypropylene allows easy viewing of the fluid level

501505	-0060	-0125	-0250	-0500	-1000
Capacity ml	60	125	250	500	1000
Neck I.D. mm	26	33	35	45	54
Cap size nom. mm	33	38	45	55	65
Height nom. mm	82	99	145	165	209
Bottle O.D. mm	40	50	60	75	90
Pack Quantity	12	12	12	12	6
Pack Price \$	37.36	40.60	57.15	67.07	40.41

### NEW Polycarbonate Graduated Bottles with PP Closures

- Autoclavable and leakproof
- Glass clear, durable and highly break resistant
- Graduated in metric and English;
- Very high quality

Boston Round bottles, Narrow Mouth. Use with biologicals, liquids, reagents, media, buffers and aqueous solutions. Manufactured in Class 10K cleanroom. Available in packs or shrink wrap trays.

601524	-0300	-0500	-1000
Size mL	300	500	1000
Closure mm	38-430	38-430	38-430
Pack Quantity	6	6	4
Pack Price \$	\$45.30	\$56.82	\$44.76
Case Quantity	24	12	12
Case Price \$	\$181.20	\$113.64	\$134.20



### Bottles, Lightweight HDPE

Molded of high density polyethylene with handle for convenient carrying. Supplied with 38 mm polypropylene closure for tight seal.

	608695	608715
Capacity gallon(s)	1/2	1
Height mm	241	317
Diameter mm	120	158
Pack Quantity	24	12
Pack Price \$	84.88	40.81



Heavy wall, wide mouth air tight PTFE bottles with screw closure have machine finish for ease in cleaning. Virtually immune to chemical attack, only attacked by some fluorine containing compounds at high temperature and molten alkalis metals. Working temperature range is from cryogenic to 260°C. Non-sticking.

BOTTLE PTFE	314804	314814	314824	314834	314844	314854	314864	314874	314884	314894
Capacity ml	1	5	10	25	50	100	250	500	1000	2000
Height mm	27	35	50	61	76	88	115	150	185	240
Diameter mm	16	22	26	33	43	52	67	80	100	120
Wall Thickness mm	2	2	2	2-3	2.5-3	2.5-3	3-4	3-4	3-4	3-4
Price Each \$	32.87	38.00	43.12	53.22	68.43	92.75	126.36	228.09	298.77	466.95

## Bottle, General Purpose



Low Density Polyethylene with HDPE Closure



Polypropylene with Polypropylene Closure



**SEE SampleSafe Seals  
on page 66**



### Wide Mouth Graduated Bottles, LDPE and PP

**Kartell**

- Leakproof

Economical, low density polyethylene bottles are flexible, translucent and have wide mouths for ease in filling. Translucent, rigid polypropylene bottles are autoclavable and can withstand temperatures up to 135°C. Maximum temperature for LDPE is 80°C. Specially designed closure provides leakproof seal and has hole for tagging. FDA compliant for food and beverage.

202415	-0050	-0100	-0250	-0500	-1000	-2000
Material	LDPE	LDPE	LDPE	LDPE	LDPE	LDPE
Capacity ml	50	105	250	500	1000	2000
Height mm	88	103	140	168	206	249
Bottle O.D. mm	38	48	60	75	95	120
Cap Size mm	32	32	45	45	63	63
Pack Quantity	10	10	10	5	5	1
Case Quantity	100	100	100	50	25	5
Case Price \$	231.54	297.44	413.99	298.43	258.31	74.86

202445	-0050	-0100	-0250	-0500	-1000	-2000
Material	PP	PP	PP	PP	PP	PP
Capacity ml	50	105	250	500	1000	2000
Height mm	88	103	140	168	206	249
Bottle O.D. mm	38	48	60	75	95	120
Cap Size mm	32	32	45	45	63	63
Pack Quantity	10	10	10	5	5	1
Case Quantity	100	100	100	50	25	5
Case Price \$	272.54	327.79	457.39	317.10	267.17	86.44

### Graduated Wide and Narrow Neck Bottles, LDPE

**Kartell**

- LDPE bottles with PP closures
- Plug and seal LDPE cap

Choice of wide or narrow neck graduated bottles will withstand considerable pressure. Secured by tagging points on bottle and cap. Confidential notes can be placed in the space between insert sealing plug and cap.

202435	-0050	-0100	-0250	-0500	-1000	-2000
Neck	Wide	Wide	Wide	Wide	Wide	Wide
Capacity mL	50	100	250	500	1000	2000
Diameter mm	40	48	61	75	93	115
Height mm	77	89	126	158	200	247
Pack Quantity	10	10	10	5	5	2
Pack Price \$	20.69	23.65	30.15	18.03	29.26	22.58

NEW 202465	-0050	-0125	-0250	-0500	-1000	-2000
Neck	Narrow	Narrow	Narrow	Narrow	Narrow	Narrow
Capacity mL	50	100	250	500	1000	2000
Diameter mm	40	48	61	75	93	115
Height mm	77	89	126	158	200	247
Pack Quantity	10	10	10	5	5	2
Pack Price \$	20.16	23.15	29.65	17.53	28.77	22.07

### Narrow Mouth Graduated Grey Bottles, PE

**Kartell**

- PE bottles with PP closures
- Plug and seal cap

These opaque leakproof bottles are excellent for storing light sensitive materials, either liquid or solid. Body in Polyethylene (PE); cap in Polypropylene (PP). A LDPE neck insert plug provides maximum security. The easy grip PP screw closure contains tag holes and may be wired securely to either of 2 shoulder holes. Sloping shoulders reduce any possibility of residue deposits. Suitable for food grade products.

201295	-0050	-0125	-0250	-0500	-1000	-2000
Capacity ml	50	125	250	500	1000	2000
Bottle O.D. mm	39	46	60	74	93	116
Height nom. mm	76.15	115	137	165	213	273
Neck I.D. mm	18.5	18.5	23	23	34.5	34.5
Case Quantity	50	50	50	25	10	2
Case Price \$	81.52	102.55	131.48	84.15	51.01	22.93





**Polycarbonate Graduated Media Bottles with Polypropylene Closure**

- Octagonal square shape for easy pouring and space storage
- Graduation markings are optically clear molded-in
- Transparent and autoclavable
- Leak-proof

Unequaled in design or performance, the octagonal square shape provides an "Easy-Grip" for pouring. Transparent and autoclavable. Use with aqueous solutions, storage of media-short term or for space saving (square) storage. The cap is made with virgin, high-temperature polypropylene (PP) and is liner-free and comes with a leak-proof guaranty. The neck ring insures security of shrink-wrapped seals and has a smooth interior so there is no fluid entrapment and no back-flow contamination. The seal ring is molded inside the cap and fits tightly against the bottle neck; insuring a leak-proof system.

626284	-0125	-0250	-0500	-1000	-2000
Capacity ml	125	250	500	1000	2000
Height mm	107	140	172	213	273
Diameter mm	54	61	73	97	114
Neck Size	38-430	38-430	38-430	38-430	53B
Case Quantity	48	36	24	24	1
Case Price \$	289.87	227.56	230.70	291.09	24.24



**SEE  
bottle carriers  
on page 32**



**Bottles PET**

- Lightweight
- Wide mouth

Transparent PET bottles with tight fitting snap-on caps which offer the advantages of excellent clarity and good chemical resistance. Temperature range is from -20°C to 80°C.

	301855	301875	301895
Capacity ml	30	50	100
Height mm	48	60	75
Bottle O.D. mm	36	42	50
Neck I.D. mm	25	36	34
Pack Quantity	10	10	10
Case Quantity	50	50	50
Case Price \$	155.75	177.31	211.06



**Bottles PVC**

- Leakproof screw closure
- Clear as glass
- Wide mouth

Clear as glass, these PVC bottles have good chemical resistance and are lightweight. Screw closures are pulp and vinyl lined bakelite. Temperature range is from -20°C to 80°C.

	301925	301935	301945	301954	301964	301974	301984
Capacity ml	50	100	200	300	500	1000	2000
Height mm	60	73	87	95	110	145	190
Width mm	38	46	59	67.5	94	110	143
Neck I.D. mm	25	33	43	42	57	70	70
Pack Quantity	12	12	12	12	12	12	12
Case Quantity	72	72	72	48	48	36	24
Case Price \$	213.30	270.22	387.82	293.74	342.65	360.48	367.99

# Bottle, Laboratory Wide Mouth



*Azlon*

## LOW DENSITY POLYETHYLENE WIDE MOUTH BOTTLES

301665	-0002	-0004	-0008	-0016	-0032
Capacity ml	60	125	250	500	1000
Height mm	82	99	145	165	209
Bottle O.D. mm	40	50	60	75	90
Neck I.D. mm	26	33	35	35	35
Cap Size mm	33	38	45	45	45
Pack Quantity	12	12	12	12	6
Case Quantity	72	72	72	48	24
Case Price \$	111.49	127.48	193.45	178.73	156.10

301675	-0004	-0008	-0016	-0032
Capacity ml	125	250	500	1000
Bulk LDPE Quantity	300	180	100	55
Bulk Price \$	345.37	347.77	235.38	208.44

## HIGH DENSITY POLYETHYLENE WIDE MOUTH BOTTLES

301605	-0001	-0002	-0004	-0008	-0016	-0032	-0064
Capacity ml	30	60	125	250	500	1000	2000
Height mm	70	82	99	145	165	209	245
Bottle O.D. mm	32	40	50	60	75	90	120
Neck I.D. mm	22	26	33	35	45	54	54
Cap Size mm	28	33	38	45	55	65	65
Pack Quantity	12	12	12	12	12	6	1
Case Quantity	72	72	72	72	48	24	6
Case Price \$	112.88	116.09	132.19	193.86	183.17	158.11	78.79

301615	-0001	-0002	-0004	-0008	-0016	-0032	-0064
Capacity ml	30	60	125	250	500	1000	2000
Bulk HDPE Quantity	1200	720	350	180	100	55	28
Bulk Price \$	912.70	600.17	380.29	340.90	250.69	203.22	234.70

## HIGH DENSITY POLYETHYLENE WIDE MOUTH AMBER BOTTLES

301645	-0005	-0008	-0016	-0032	-0064
Capacity ml	150	250	500	1000	2000
Height mm	105	145	165	209	245
Bottle O.D. mm	50	60	75	90	120
Neck I.D. mm	26	35	45	54	54
Cap Size mm	33	45	55	65	65
Pack Quantity	12	12	12	6	1
Case Quantity	72	72	48	24	6
Case Price \$	161.81	243.71	214.32	187.34	90.47

### LDPE Bottles

- Leakproof
- Translucent
- FDA compliant resin
- Flexible
- Polypropylene closure

### HDPE Bottles

- Leakproof
- Translucent
- FDA approved resin
- Rigid
- Polypropylene closure

### PP Bottles

- Leakproof
- Translucent
- Autoclavable
- FDA compliant resin
- Rigid
- Polypropylene closure

### HDPE Amber Bottles

- Leakproof
- For light sensitive materials
- FDA approved resin
- Rigid
- Black polypropylene closure

### PP Amber Bottles

- Leakproof
- Autoclavable
- For light sensitive materials
- FDA Approved Resin
- Rigid
- Black polypropylene closure

## POLYPROPYLENE WIDE MOUTH BOTTLES

301625	-0001	-0002	-0004	-0008	-0016	-0032	-0064
Capacity ml	30	60	125	250	500	1000	2000
Height mm	70	82	99	145	165	209	245
Bottle O.D. mm	32	40	50	60	75	90	120
Neck I.D. mm	22	26	33	35	45	54	54
Cap Size mm	28	33	38	45	55	65	65
Pack Quantity	12	12	12	12	12	6	1
Case Quantity	72	72	72	72	48	24	6
Case Price \$	117.59	119.62	147.52	231.27	216.00	158.31	88.36

301635	-0001	-0002	-0004	-0008	-0016	-0032	-0064
Capacity ml	30	60	125	250	500	1000	2000
Bulk PP Quantity	1200	700	350	180	100	55	28
Bulk Price \$	1,144.46	743.87	447.81	377.18	285.68	250.56	257.51

## POLYPROPYLENE WIDE MOUTH AMBER BOTTLES

301825	-0060	-0150	-0250	-0500	-1000	-2000
Capacity ml	60	150	250	500	1000	2000
Height mm	82	99	145	165	209	245
Bottle O.D. mm	40	50	60	75	90	120
Neck I.D. mm	26	33	35	45	54	54
Cap Size mm	33	38	45	55	65	65
Pack Quantity	10	10	10	10	5	1
Case Quantity	70	70	70	50	25	5
Case Price \$	148.00	154.20	248.36	236.55	198.12	79.83

Bulk Azlon bottles can be fluorinated upon request. Note: Not stock items, lead times and minimums apply.

*Azlon*

## LOW DENSITY POLYETHYLENE NARROW MOUTH BOTTLES

301685	-0001	-0002	-0004	-0008	-0016	-0032
Capacity ml	30	60	125	250	500	1000
Height mm	66	79	103	143	165	202
Bottle O.D. mm	32	40	50	60	75	90
Neck I.D. mm	16	16	22	21	21	21
Cap Size mm	22	22	28	28	28	28
Pack Quantity	12	12	12	12	12	6
Case Quantity	72	72	72	72	48	24
Case Price \$	82.02	85.68	110.16	159.12	146.10	122.38

301695	-0004	-0008	-0016	-0032
Capacity ml	125	250	500	1000
Bulk Quantity	350	180	100	55
Bulk Price \$	410.96	271.09	205.50	192.23

## HIGH DENSITY POLYETHYLENE NARROW MOUTH BOTTLES

301705	-0001	-0002	-0004	-0008	-0016	-0032	-0064
Capacity ml	30	60	125	250	500	1000	2000
Height mm	66	79	103	143	165	202	235
Bottle O.D. mm	32	40	50	60	75	90	120
Neck I.D. mm	16	16	22	21	21	21	32
Cap Size mm	22	22	28	28	28	28	45
Pack Quantity	12	12	12	12	12	6	1
Case Quantity	72	72	72	72	48	24	6
Case Price \$	82.02	84.45	108.95	156.63	147.68	130.59	74.67

301715	-0001	-0002	-0004	-0008	-0016	-0032	-0064
Capacity ml	30	60	125	250	500	1000	2000
Bulk Quantity	1200	720	350	180	100	55	28
Bulk Price \$	1,044.25	646.86	360.53	271.10	205.07	179.82	266.07

## HIGH DENSITY POLYETHYLENE NARROW MOUTH AMBER BOTTLES

301745	-0005	-0008	-0016	-0032	-0064
Capacity ml	150	250	500	1000	2000
Height mm	116	143	165	202	235
Bottle O.D. mm	50	60	75	90	120
Neck I.D. mm	22	21	21	21	32
Cap Size mm	28	28	28	28	45
Pack Quantity	12	12	12	6	1
Case Quantity	72	72	48	24	6
Case Price \$	153.26	187.34	182.36	154.33	74.53

## POLYPROPYLENE NARROW MOUTH BOTTLES

301725	-0001	-0002	-0004	-0008	-0016	-0032	-0064
Capacity ml	30	60	125	250	500	1000	2000
Height mm	66	79	103	143	165	202	235
Bottle O.D. mm	32	40	50	60	75	90	120
Neck I.D. mm	16	16	22	21	21	21	33
Cap Size mm	22	22	28	28	28	28	45
Pack Quantity	12	12	12	12	12	6	1
Case Quantity	72	72	72	72	48	24	6
Case Price \$	94.29	96.46	120.58	171.45	181.26	141.70	85.50

301735	-0001	-0002	-0004	-0008	-0016	-0032	-0064
Capacity ml	30	60	125	250	500	1000	2000
Bulk Quantity	1200	720	350	180	100	55	28
Bulk Price \$	1,137.62	700.49	481.78	335.79	273.26	243.02	252.45



HDPE Amber

LDPE

PP



**SEE  
bottle carriers  
on page 32**

### PLEASE NOTE

Remove or make sure closure threads are completely disengaged before autoclaving or sterilizing by gas or by heat.

## Bottle, Safety - Bottle, Square

*Azlon*



### Round Concertina Bottle HDPE

- Collapsible, adjustable volume
- Ideal for photographic chemicals and hydrogen peroxide

These amber collapsible bottles are ideal for solutions that readily oxidize, or those that liberate gases. The bellows convolution of the walls allow the bottle volume to be adjusted to match the volume of contents and eliminate air space as liquid is drawn off or added.

	501835
Capacity ml	1000
Height mm	201
Diameter mm	100
Neck I.D. mm	32
Case Quantity	5
Case Price \$	33.64

Suitable for use with gas liberating solutions, e.g. hydrogen peroxide.



### Narrow Mouth Bottles, HDPE with White Tamper-Evident HDPE Screw Closures

**Kartell**

The tamper-evident cap incorporates a safety ring which is secured when the cap is screwed on to the bottle. Opening the bottle breaks the safety ring, showing signs of interference.

202455	-0050	-0100	-0250	-0500	-1000
Capacity mL	50	100	250	500	1000
Diameter mm	36	44	60	74	90
Height mm	84	101	136	170	220
Case Quantity	100	100	50	30	20
Case Price \$	162.69	171.44	134.08	100.26	92.34



### Graduated Rectangular Bottles HDPE

- Ideal for powders and granules
- Economical on shelf space
- Maximum temperature 110°C
- Food Grade
- Includes mouth insert plug for added security

Lightweight rectangular bottles with plug seal blue screw caps. Closure and insert are made of HDPE. Feature molded in graduations for approximate volume measurements. Supplied capped in shrink-wrapped packs.

501305	-0500	-1000	-2000
Capacity ml	500	1000	2000
Height mm	120	180	235
Width mm	75	75	92
Length mm	75	94	108
Neck ID mm	58	58	58
Pack Quantity	10	5	5
Pack Price \$	53.78	30.38	42.76

*Azlon*



### Graduated Square Bottles, HDPE with HDPE Screw Closures

**Kartell**

Choice of amber or natural graduated 2 liter HDPE rectangular bottles for space saving storage. Enhanced stability when in use with an ergonomic hand grip allowing for greater ease in pouring. Screw capped and graduated to 2000 mL. Bottle Dimensions (l x w x h): 3.75" x 4.5" x 9.65".

201315-2000A	Amber 2L Bottle	\$68.81 pack of 6
201315-2000W	White 2L Bottle	\$65.62 pack of 6



**SEE SampleSafe Seals  
on page 66**



**Graduated Rectangular Bottles HDPE**

Convenient square design saves space. The integrity of the seal is insured by the additional internal plug. Hole in closure for attachment of tag. Maximum temperature for High Density Polyethylene is 110°C.

**Kartell**

226295	-0025	-0050	-0100	-0250	-0500	-1000	-2000
Capacity ml	25	50	100	250	500	1000	2000
Height mm	52	70	90	110	138	176	210
Width mm	24	38	48	60	80	103	134
Depth mm	32	38	42	57	70	80	100
Neck ID mm	18	24	34.5	34.5	45	58	58
Pack Quantity	10	10	10	10	6	6	6
Case Quantity	100	100	100	100	36	24	12
Case Price \$	159.55	177.20	249.94	287.17	144.71	152.46	139.73

**Bottles, Dispensing LDPE**

Low-cost wash bottles, narrow mouth supplied with dispensing unit. The fine bore dispenser tubing through the closure can be cut back to increase flow. Dispense controlled stream, quick spurt or drop by drop. Maximum temperature of LDPE is 80°C.

**LDPE WASH OR DISPENSING BOTTLES - NEEDLE SPRAY**

106105	-01	-02	-04	-08	-16	-32
Capacity ml	30	60	125	250	500	1000
Height w/o cap mm	74	84	108	137	154	220
Bottle Diameter mm	30	36	47	60	79	94
Cap Size mm	15	18	24	24	28	28
Pack Quantity	12	12	12	12	12	6
Case Quantity	48	48	48	36	24	12
Case Price \$	159.14	156.67	187.59	160.02	129.38	86.77

**LDPE WASH OR DISPENSING BOTTLES - LARGE TUBING**

106155	-04	-08	-16	-32
Capacity ml	125	250	500	1000
Height w/o cap mm	108	137	154	220
Bottle Diameter mm	47	60	79	94
Cap Size mm	24	24	28	28
Pack Quantity	12	12	12	6
Case Quantity	48	36	24	12
Case Price \$	155.27	138.90	113.82	74.86



**Bottles, 1 Quart Square Tamper Evident, HDPE**

These durable 1 quart bottles are made of FDA compliant HDPE resin. Bottles have a one-quart capacity-choose either tall bottles or short bottles with handle. Both models have a tamper evident 38-mm polypropylene cap with a polyethylene liner that protects against leaks.

	608724	608754
Capacity quart	1	1
Height inches	6	9.375
Width inches	3.625	2.75
Pack Quantity	12	12
Pack Price \$	18.56	15.47



**Needle Spray**

**Large Tubing**

## Bottle, Wash



### Solvent Venting Wash Bottles

Azlon

- Wide mouth for easy filling
- Eliminates unwanted jets of solvent
- Dispenses solvents efficiently
- Eliminates solvent dripping

These LDPE Driplok Wash Bottles with PP closures feature the only venting system that dispenses solvent as efficiently as a standard wash bottle. This venting system consists of a valve specifically designed to allow volatile solvent vapors to escape, but seals completely when in use to dispense a powerful, spatter-free jet of solvent. These easy to fill bottles are available labeled with hazard information, or blank with write on for customization.

506455	-0001	-0002	-0004	-0005	-0006
Capacity ml	250	250	250	250	250
Height mm	145	145	145	145	145
Diameter mm	60	60	60	60	60
Printed	Acetone	Ethanol	Isopropanol	Methanol	All 250ml
Pack Quantity	5	5	5	5	1
Pack Price \$	41.45	41.45	41.45	41.45	43.50

506465	-0001	-0002	-0004	-0005	-0006
Capacity ml	500	500	500	500	500
Height mm	165	165	165	165	165
Diameter mm	75	75	75	75	75
Printed	Acetone	Ethanol	Isopropanol	Methanol	All 500ml
Pack Quantity	5	5	5	5	1
Pack Price \$	43.38	43.38	43.38	43.38	45.64

506475	-0001	-0002
Capacity ml	250	500
Height mm	145	165
Diameter mm	60	75
Printed	Write-on	Write-on
Pack Quantity	5	5
Pack Price \$	45.17	45.74

The Azlon® Driplok system (illustrated below) is the ONLY solvent vapor venting bottle that dispenses as efficiently as a normal wash bottle due to the patented ball valve system.

**No spit...no sputter!**

driplok

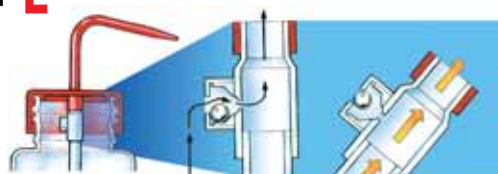

### Tracker Bottles, LDPE

Azlon

- Allows full traceability of solutions
- All information is clearly visible to users, at all times
- Easy to re-use, time and time again
- DripLok® vapor venting version ensures safe use with volatile solvents
- Self-adhesive COSHH labels supplied with all bottles

With and without the Driplok® Vent these new LDPE wash bottles are designed to allow for full traceability of solutions. The bottle has been designed with a series of designated labeled areas, including spaces to record the following information.

- Originator
- Date of receipt
- Lot number
- Bottle contents
- First use date
- Expiration date
- Spaces for COSHH hazard symbols

506995	-0001	-0002	-0003	-0004	WGWPEN01
Description	Standard	Standard	DripLok®	DripLok®	Indelible
Capacity ml	250	500	250	500	Marker
Height mm	145	165	145	1165	Pen
Diameter mm	60	75	60	75	NA
Case Quantity	5	5	5	5	2
Case Price \$	37.02	36.26	46.19	45.60	45.47



### Round Wide Neck Printed Water Wash Bottles LDPE

These high quality wash bottles are supplied in flexible natural polyethylene and are fitted with leak proof, wide neck polypropylene spout closures. The wide neck offers easy spill-free filling, and the acute angled, precision molded dispensing spout, ensures a consistent, downward pointing jet. The wash bottles are supplied in shrink-wrapped packs of five. All feature S.P.I recycling codes on their base. Maximum temperature of LDPE is 80°C.



**Biological Stain Bottle Kit**

*Azlon*

Stain series Driplok venting wash bottles preprinted for five popular biological stains. Printed for Lugols Iodine Solution, Crystal Violet, Gram Color De-coloring Solution, Gram Iodine Solution and Safranin Solution. Printed information includes hazard warning symbols where relevant and instructions for use. Dark colored stain bottles are printed in light colors for easy recognition of contents. Consists of five assorted 250ml bottles labeled as above.

507005 Biological Stain Bottle Set \$45.57 Pack 5



**Round Wide Neck Wash Bottle LDPE**

*Azlon*

These high quality wash bottles are supplied in flexible natural polyethylene and are fitted with a range of color coded leak proof, wide neck polypropylene spout closures.

The wide neck offers easy spill-free filling, and the acute angled, precision molded dispensing spout, ensures a consistent, downward pointing jet. The wash bottles are supplied in shrink-wrapped packs of five. All feature S.P.I recycling codes on their base. Maximum temperature of LDPE is 80°C.

506925	-0001	-0002	-0003	-0004	-0005
Capacity ml	250	250	250	250	250
Height mm	145	145	145	145	145
Diameter mm	60	60	60	60	60
Cap Color	White	Red	Yellow	Green	Blue
Pack Quantity	5	5	5	5	5
Pack Price \$	28.07	26.93	26.93	28.07	26.93

506935	-0001	-0002	-0003	-0004	-0005
Capacity ml	500	500	500	500	500
Height mm	165	165	165	165	165
Diameter mm	75	75	75	75	75
Cap Color	White	Red	Yellow	Green	Blue
Pack Quantity	5	5	5	5	5
Pack Price \$	31.19	31.19	30.75	30.75	30.75

506945	-0001	-0002	-0003	-0004	-0005
Capacity ml	1000	1000	1000	1000	1000
Height mm	209	209	209	209	209
Diameter mm	90	90	90	90	90
Cap Color	White	Red	Yellow	Green	Blue
Pack Quantity	5	5	5	5	5
Pack Price \$	34.93	33.48	33.48	33.48	33.48

**NEW**



**NEW Wash Bottle, Autoclavable, PP**

*Azlon*

- Autoclavable at 121°C
- PP 500mL bottle fitted with one-piece PP closure (34mm neck ID)
- Closures feature precision jet-tip aperture for fine control
- Dimensions 163 height x 75mm diameter

506985 \$44.95 case of 5

506955	-0001	-0002	-0003
Capacity ml	250	250	250
Height mm	145	145	145
Diameter mm	60	60	60
Printed	Water	Distilled	Deionized
Cap Color	White	White	White
Pack Quantity	5	5	5
Pack Price \$	37.21	37.21	37.21

*Azlon*

506965	-0002	-0003
Capacity ml	500	500
Height mm	165	165
Diameter mm	75	75
Printed	Distilled	Deionized
Cap Color	White	White
Pack Quantity	5	5
Pack Price \$	41.93	40.27

## Bottle, Wash



## NEW - GHS

### Multi-lingual Wide Mouth Wash Bottles

- Multi-lingual wide mouth wash bottles featuring the patented DripLok® vapor venting valve that prevents solvent drips
- Indelibly printed in 4 languages (English, French, German & Spanish)
- Choose from four solvent labels, all including the new Globally Harmonized Symbols, NFPA diamond, risk phrases & safety information
- Fitted with color coded one-piece PP closures that maintain their shape in use
- Closures feature precision jet-tip aperture for fine control



506485	-0001	-0002	-0003	-0004	-0005
Capacity ml	250	250	250	250	250
Height mm	145	145	145	145	145
Diameter mm	60	60	60	60	60
Printed	Acetone	Ethanol	Isopropanol	Methanol	All 250ml
Pack Quantity	5	5	5	5	1
Pack Price \$	36.13	36.13	36.13	36.13	30.34

506495	-0001	-0002	-0003	-0004	-0005
Capacity ml	500	500	500	500	500
Height mm	165	165	165	165	165
Diameter mm	75	75	75	75	75
Printed	Acetone	Ethanol	Isopropanol	Methanol	All 500ml
Pack Quantity	5	5	5	5	1
Pack Price \$	37.81	37.81	37.81	37.81	31.85

The Azlon® Driplok system (illustrated below) is the **ONLY** solvent vapor venting bottle that dispenses as efficiently as a normal wash bottle due to the patented ball valve system.

**No spit...no sputter!**

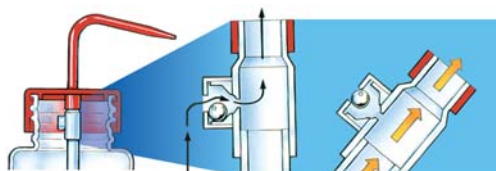

### Round Narrow Neck Wash Bottles LDPE

*Azlon*

Four sizes of traditional style wash bottles fitted with color coded, polypropylene swivel/leak-proof closures. Supplied capped in shrink-wrapped packs of five. Maximum temperature of LDPE is 80°C.

506705	-0060	-0150	-0250	-0500
Capacity ml	60	150	250	500
Height mm	79	110	143	165
Diameter mm	40	50	60	75
Pack Quantity	5	5	5	5
Pack Price \$	14.50	17.76	20.92	22.77



### Colored Narrow Neck Wash Bottles LDPE

*Azlon*

Traditional style wash bottles in four colors with matching closures. Supplied capped in shrink-wrapped packs of five. Maximum temperature of LDPE is 80°C.

	506755 -0500	506785 -0500	506765 -0500	506775 -0500
Capacity ml	500	500	500	500
Color	Red	Yellow	Green	Blue
Height mm	165	165	165	165
Diameter mm	75	75	75	75
Pack Quantity	5	5	5	5
Pack Price \$	22.80	21.72	22.80	21.72





**Printed Sloping Shoulder Wash Bottles LDPE**



These stylish sloped shoulder wash bottles are available with seven different printed labels. All are fitted with color coded polypropylene swivel/leak proof closures featuring an acute angled "swan neck" dispensing spout. Maximum temperature of LDPE is 80°C.

506905	-0001	-0002	-0004	-0006
Capacity ml	250	250	250	250
Color	White	White	Red	Blue
Printed	Water	Distilled	Acetone	Isopropanol
Height mm	150	150	150	150
Diameter mm	50	50	50	50
Pack Quantity	5	5	5	5
Pack Price \$	25.52	29.17	27.12	27.09

506915	-0001	-0002	-0004	-0005	-0006	-0008
Capacity ml	500	500	500	500	500	500
Color	White	White	Red	Green	Blue	Orange
Printed	Water	Distilled	Acetone	Methanol	Isopropanol	Ethanol
Height mm	185	185	185	185	185	185
Diameter mm	64	64	64	64	64	64
Pack Quantity	5	5	5	5	5	5
Pack Price \$	30.82	29.07	32.68	32.21	29.09	29.07



**Sloping Shoulder Wash Bottles LDPE**



These stylish sloped shoulder wash bottles are available in three popular sizes. All are fitted with color coded polypropylene swivel/leak proof closures featuring an acute angled "swan neck" dispensing spout.

506805	-0250	-0500	-1000
Cap Color	White	White	White
Capacity ml	250	500	1000
Height mm	150	185	240
Diameter mm	50	64	80
Pack Quantity	5	5	5
Pack Price \$	19.50	22.77	25.79

506815	-0250	-0500	-1000
Cap Color	Red	Red	Red
Capacity ml	250	500	1000
Height mm	150	185	240
Diameter mm	50	64	80
Pack Quantity	5	5	5
Pack Price \$	19.69	23.57	27.34

**Kartell**

**Easy Squeeze Wash Bottles LDPE**

Easy-squeeze wash bottles with integrally molded tube. Requires only gentle pressure to eject and accurately direct the liquid. The dispensing tip can be cut back to increase the flow rate. Maximum temperature of LDPE is 80°C.



	224085	224115
Capacity ml	250	500
Height mm	144	180
Diameter mm	60	65
Pack Quantity	36	24
Pack Price \$	176.34	149.60



**Economy Integral Style Wash Bottle LDPE**

These wash bottles have an integrally molded tube with removable jet tip and a separate plain Polypropylene cap. The shape is a squared-oval for easy grip and improved stability. Can be supplied with the tube end sealed for transportation when filled. Maximum temperature of LDPE is 80°C.

	506535-0250	506535-0500
Capacity ml	250	500
Color	Natural	Natural
Pack Quantity	5	5
Pack Price \$	29.36	34.41

## Bottle, Weigh - Bucket, Ice



### Weighing Bottles PP with PP Lids

- Autoclavable, reusable translucent bottles
- Airtight, push on lids included
- No internal shoulder eliminates need for spatulas
- For liquids or solids

Reduce the tare weight correction with these light weight, autoclavable, reusable translucent bottles. Highly resistant to acid attack. Tops can be squeezed to assist pouring. Remove lid before autoclaving. Very economical compared to glass.

261154	-0001	-0002	-0003	-0004
Volume mL	20	23	30	50
O.D. mm	40	30	49	59
Height mm	29	48	29	34
Tare g	8	8	10	18
Pack Quantity	10	10	10	10
Pack Price \$	56.52	57.34	58.05	65.62

261154	-0005	-0006	-0007
Volume mL	60	190	360
O.D. mm	40	59	70
Height mm	69	88	118
Tare g	14	28	40
Pack Quantity	10	10	10
Pack Price \$	67.39	82.17	98.61

## Kartell



### Bottle Carriers HDPE with HDPE Lab Bottles

Fabricated of high density polyethylene and supplied with either 301605 HDPE Azlon® Laboratory Bottles from page 24 or 608715 Lightweight HDPE Bottles from page 21. A safe and easy method of carrying bottles. External dimensions are 14 1/2" x 8" x 6 1/4" deep. Single, six and eight compartment carriers supplied with 1" diameter carrying handle. Two compartment carrier supplied with center mounted divider handle.



	165024	165034	165044	165054
Compartments	1	6	2	8
Bottle Capacity ml	NA	1000	2000	500
Compartment Dimensions:				
Length inches	14	4 1/2	6 7/8	3 1/4
Width inches	7 1/2	3 5/8	7 1/2	3 5/8
Depth inches	6	6	6	6
Price Each \$	177.64	234.11	231.98	262.77

### Economy Bottle Carrier HDPE

Lightweight, sturdy bottle carrier provides economical means to transport up to six 1 Liter bottles (3 1/2" diameter or smaller). Overall dimensions approximately 13" x 9 3/4" x 4 1/4" deep compartments. Handle is approximately 6" high.



408175 \$140.03 pack of 5



### Hazardous Chemical Bottle Pourer

The hazardous and corrosive chemical pourer is manufactured fully from PTFE and has totally inert pouring surfaces, even the neck-sealing ring is encapsulated in PTFE. The unique design allows direct and controlled pouring due to the incorporated breather vent. The pourer comes in four sizes to fit standard reagent bottles with neck sizes of GL45, 38, 32 and 30. A captured PTFE closure ensures contaminant free contents when not in use. (Bottle not included.)

310374	-0001	-0002	-0003	-0004
Neck Size mm	45	32	30	38
Price Each \$	68.00	68.00	68.00	68.00



### Ice Bucket

- 4.5 Liter capacity
- Will not sweat or leak
- Resistant to acetone
- Unbreakable in normal use
- Maximum temperature 95°C
- Can be chemically disinfected
- Molded handles for safe handling

Durable rigid polyurethane skinned-foam construction. Excellent insulating properties, suitable for use with dry ice, water ice and salt solutions. Octagonal design will not deform and is very stable when full. Flush lid with recessed handle means buckets can be stacked for storage. Dimensions: Internal Base 155mm, External Base 185mm, Internal Rim 245mm, External Rim 275mm (325 with handles)

501864 \$110.59 each

Azlon

# Burette

*Azlon*



## Titrating Burette Automatic

This automatic titrating burette is a universal aid in the laboratory, electroplating industry, water treatment plants, for field analyses and numerous other applications. Available in 5 sizes from 5mL to 50mL. Prominent features include:

- Measured "to deliver"
- Burette made of Schott graduated borosilicate glass with blue ring graduations and Schellbach stripe for easy read measurements
- Graduations in accordance with Category B (Tolerances according to DIN ISO 385)

- Exact dispensing of precise discharge jet or drop via the micro screw
- Left or right hand operation for ease of use
- Sturdy stand for support
- 1 liter low density polyethylene (LDPE) chemically resistant bottle

896954	-1005	-1010	-1015	-1025	-1050
Capacity mL	5	10	15	25	50
Division mL	0.05	0.05	0.10	0.10	0.10
Precision mL	± 0.015	± 0.030	± 0.045	± 0.045	± 0.045
Height cm	48	57	49	61	87
Price Each \$	116.17	116.17	116.17	116.17	135.71



## Burette Clamps PP

*Azlon*

These spring loaded polypropylene clamps allow a clear view of the graduations over the entire length of a burette. The arms are fitted with rubber grips to prevent slipping and the central boss features a conical compression piece which provides a firm grip on rods 11 - 14mm diameter. Available as a single or double model.

	562415	562425
Model	Single	Double
Pack Quantity	5	5
Pack Price \$	55.33	78.68

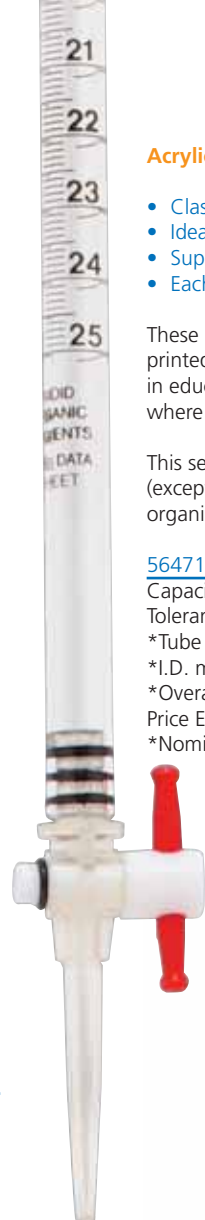

## Acrylic Burette

- Class B accuracy
- Ideal for use in educational environment
- Supplied with PMP/PP stopcocks
- Each burette supplied with technical data sheet

These break resistant transparent acrylic burettes are screen printed in black to Class B accuracy. They are suitable for use in education, research or industrial laboratories, especially where breakages often occur.

This series is unaffected by most dilute aqueous solutions (except ammonia and HF) but unsuitable for ethanol or organic solvents. Individually calibrated.

564715	-0025	-0050	-0100
Capacity ml	25	50	100
Tolerance +/- ml	.1	.1	.2
*Tube Length mm	480	680	735
*I.D. mm	89.5	10.8	14.6
*Overall Length mm	550	750	805
Price Each \$	74.67	94.03	111.52
*Nominal			

**SEE  
burette rack  
on page 77**



## Burette, Retort Stand

*Azlon*

- Corrosion resistant
- Weighted for stability

This heavy white polyethylene resistant stand weighs 5.5lbs. It comes with a polyethylene coated metal rod which screws into the base. Available with the hole in the center or at the short edge. The base dimensions are: 171 x 248 x 52mm (6 3/4" x 9 7/8" x 2 1/16"). Rod diameter is 12.5mm. Burette clamps available at left.

502655	Center Rod Stand	\$110.32 each
502665	Edge Rod Stand	\$110.32 each



**Baritainer® Jerry Cans**

Baritainer® Jerry Cans with handle (4L, 5L, 10L and 20L) from Dynalon are the new alternative solution for packaging, storing & transporting chemicals that usually require glass, metal, fluorinated HDPE or other single barrier containers.

Baritainers are impact resistant, lightweight, rugged, economical & stackable containers for chemicals. Baritainers are effective containers for solvents, esters, ketones and some acids.

- Replaces fluorinated, glass, steel and epoxy phenolic
- Impact and corrosion resistant
- FDA Compliant

- UN Classification X Rated (4L, 5L, 10L) Y Rated (20L)
- Durable, lightweight, stackable
- Economical and Recyclable

EFFICACY:

- Solvents: up to 300x of HDPE
- Oxygen: up to 100x of HDPE
- Fluorinated: up to 2X more efficient barrier

COMPARED TO HDPE:

- Quoral BR is 100x more efficacious with hydrocarbon solvents
- Provides an excellent aroma barrier
- 2x to 5x improvement in O2 barrier performance

KEY APPLICATIONS:

QUORAL® (patent pending) based Baritainer Jerry Cans have been extensively tested both for efficacy and safety. They can be used to safely dispense, store and transport solvents such as household chemicals, industrial & laboratory chemicals and waste, cleaning solvents, adhesives, wood preservatives, automotive additives, chemicals in the agricultural, automotive photo chemical sector. Baritainers can be used to safely store and transport food ingredients, flavorings, edible oils, essential oils and other industry products such as cosmetics and fragrances. Baritainer Jerry Cans offer an attractive and environmentally friendly alternative to glass, metal containers, coextruded or fluorinated containers and other single-layer barrier containers, polyester and PVC containers.

SPECIFICATIONS:

UN X or UN Y rated Jerry Can with screw closure. Closure size: DIN 50 (4L, 5L, 10L) or Natural 70mm (20L) with tamper-evident system. HDPE maximum temperature: 248°F (120°C) and minimum temperature: -148°F (-100°C). Not autoclavable.

COMPOSITION:

Jerry Can: Natural, QUORAL® (pat. pend.) and HDPE  
Screw cap: Black HDPE. Screw cap Inner liner: cross link polyethylene (4L, 5L, 10L) Natural HDPE with 3/4" NPT Center Reducer screw cap and EPDM liner (20L)

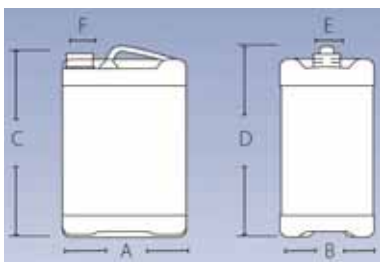

405594	-0004	-0001	-0002	-2070	-0275
Capacity gallons (liters)	1.1 (4)	1.32 (5)	2.64 (10)	5.28 (20)	
Weight lbs (grams)	0.6 (286)	0.6 (272)	1.3 (590)	2.65 (1202)	144 (65.31 Kg)
A - Length inches (mm)	7.25 (125)	7.5 (190)	8.75 (222)	10.1 (265)	48 (121.92 cm)
B - Width inches (mm)	5.5 (140)	5.7 (145)	7.25 (184)	10.9 (277)	40 (101.6 cm)
C - Height inches (mm)	8.3 (211)	9.2 (235)	12.0 (305)	14.3 (363)	46 (116.84 cm)
D - Height to Handle inches (mm)	8.5 (216)	9.8 (250)	12.5 (318)	14.7 (374)	
F - Neck inches (mm)	1.6 (41)	1.6 (41)	1.6 (41)	2.755 (70)	2.25 (5.71 cm)
E - Cap	DIN 50	DIN 50	DIN 50	70mm	
Price Each US \$	8.06	10.81	16.38	29.96	612.00



Dynalon Item#: 405594-0008  
BARITAINER SPIGOT CLOS DIN50  
\$16.95 each



Dynalon Item#: 405594-0010  
BARITAINER POPUP CLOS DIN50  
\$2.10 each



Baritainer® Jerry Can Accessories



Dynalon Item#: 405594-0014  
BARITAINER WRENCH DIN50  
\$21.92 each



Dynalon Item#: 405594-0017  
BARITAINER SPIGOT, SELF VENT, 3/4"  
\$20.99 each



Jug LDPE

This one gallon jug is molded of low density polyethylene with convenient, finger ring for easy handling. Supplied with a 38 mm buttress screw closure. Heavy weight for long service. Maximum temperature for LDPE is 80°C. Product Dimensions (diameter x height): 6" x 13"

608704 \$334.69 pack of 6



Heavy Walled Wide Mouth Carboy HDPE with Neck Insert

**Kartell**

Ideal for liquid or powders. Made from food grade chemical resistant HDPE with LDPE neck insert plug that provides maximum security. Heavy duty swing handle aids in carrying. HDPE closure contains tag holes and finger grips for ease of opening. Heavy duty swing handle aids carrying.

	-0005	-0010
Capacity L	5	10
Bottle O.D. mm	163	210
Height nom. mm	315	390
Neck I.D. mm	90	120
Price Each \$	28.45	42.34



Carboy, Light & Heavy Weight HDPE

This carboy range features large carrying handles and indented hand grips on bottom for easy carrying and pouring. These carboys are supplied with 63mm HDPE closures that are threaded and can be drilled to accept screw in faucets. Carboys are made with food grade resins, are leakproof but not considered to be a shipping container. Maximum temperature for HDPE is 110°C.

	405604	405614	405624	612935
Carboy Description	Light	Light	Heavy	PE Faucet
Capacity gallon(s)	5	2 1/2	5	N/A
Length mm	245	245	245	N/A
Height mm	342	185	342	N/A
Width mm	248	187	248	N/A
Pack Quantity	4	4	4	12
Pack Price \$	81.26	70.65	131.45	74.84



NEW  
50L

Heavy Walled Narrow Mouth Carboy HDPE

**Kartell**

Made from food grade chemical resistant HDPE. Especially suited for storing liquids. The HDPE closure contains tag holes for identification and a rubber o-ring for added security. Heavy duty swing handle aids in carrying.

	-0005	-0010	-0025	-0050
Capacity L	5	10	25	50
Bottle O.D. mm	163	210	379	366
Height mm	345	425	565	700
Neck NS	46	55	55	55
Handles	1	1	2	2
Price Each \$	28.45	43.70	67.84	142.10

# Carboy



## Autoclavable Carboys and Large Bottles, PP

*Azlon*

- Range of high performance large bottles and carboys in a choice of three sizes
- Autoclavable PP, heavy-duty construction
- FDA compliant resin
- Stylish rounded octagonal shape for increased rigidity when full
- Offset neck for easier filling and pouring
- Integral, comfortable blow molded handles for ease of carrying are end-sealed to prevent contamination
- Heavy-duty closures are compatible with other leading brands
- Carboys feature a durable and leak-proof heavy-duty spigot with boss fitting for extra strength
- Spigot features removable tube fitting for added convenience
- Molded graduations allow easy viewing of contents

## Carboy with Spigot LDPE

Heavy-duty carboy is molded of low density polyethylene. Spigot is 3/4" and has serrated tip to securely hold 1/2" to 5/8" I.D. tubing. Five gallon size is supplied with one molded carrying handle. Maximum temperature for LDPE is 80°C.

	105414	105424	105444
Capacity gallon(s)	1	2	6 1/2
Height mm	355	406	635
Diameter mm	152	190	267
Pack Quantity	6	6	1
Pack Price \$	470.70	634.17	156.38

### CARBOY WITH SPIGOT

505634	-1	-2	-3
Capacity Liters	5	10	20
Cap size nom. mm	45	90	90
Height nom. mm	270.5	359	419
Width nom. mm	190	238	300
Length nom. mm	190	238	300
Price Each \$	61.47	86.52	103.63

### BOTTLE (NO SPIGOT)

505634	-4	-5	-6
Capacity Liters	5	10	20
Cap size nom. mm	45	90	90
Height nom. mm	270.5	359	419
Width nom. mm	190	238	300
Length nom. mm	190	238	300
Price Each \$	39.23	64.70	81.82

505634-7 Replacement spigot - above carboys \$21.77 each



**Kartell**

## Heavy Walled Narrow Mouth Carboy with Spigot, HDPE

Made from food grade resin, the HDPE closure with tag holes includes an o-ring for added security. The spigot with gasket is leakproof and screws directly into a welded wall insert. Very resistant to many common chemicals, these carboys provide great value for the economical price. Heavy duty swing handle aids in carrying.

208605	-0005	-0010	-0025	-0050	212905
Capacity L	5	10	25	50	Spigot
Mouth I.D. mm	52.5	52.5	79.5	79.5	
Mouth O.D. mm	62.5	62.5	95.5	95.5	
Diameter O.D.	170	210	280	350	
Height w/ Handles mm	345	425	565	700	
Handles	1	1	2	2	
Price Each \$	43.23	53.70	86.25	176.87	8.84

## Carboy With Outlet HDPE

Molded of high density polyethylene. 5 gallon (19 liter) square style saves space. Large handle on top and handgrip on bottom for convenient pouring. 63mm closure molded of low density polyethylene. The serrated tubing outlet is made for 3/8" through 1/2" I.D. tubing. Maximum temperature for HDPE is 110°C. Product Dimensions (l x w x h): 9" x 10" x 15"

105775 \$55.26 each



## Carboy - Carboy Spill Tray



**Carboy, Aspirator with Stopcock HDPE** *Azlon*

These general purpose, heavy duty bottles are not to be confused with the lightweight containers. All sizes have handles. The 5 and 10 liter sizes are hexagonal while the 25 liter is round. Maximum temperature of HDPE is 110°C.

508655	-0005	-0010	-0025
Capacity Liters	5	10	25
Height mm	324	368	610
Diameter mm	209	241	273
Neck I.D. mm	49	49	64
Price Each \$	54.02	75.60	144.92

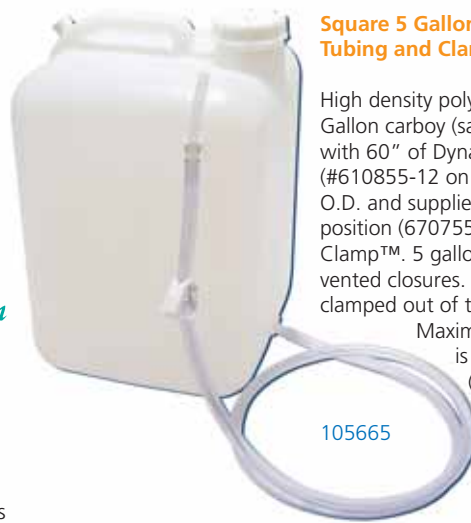

**Square 5 Gallon Carboy with Tubing and Clamp HDPE**

High density polyethylene square shaped 5 Gallon carboy (same as 405604 on page 35) with 60" of Dynalon vinyl food grade tubing (#610855-12 on page 99) 3/8" I.D., 1/2" O.D. and supplied with a standard 15 position (670755 on page 38) Dura-Clamp™. 5 gallon capacity. Supplied with vented closures. Hose tubing can be clamped out of the way when not in use.

Maximum temperature for HDPE is 110°C. Product Dimensions (l x w x h): 9.5" x 10" x 15"

105665

\$62.85 each

See Food Grade Tubing on page 99  
Dura-Clamp on page 38



**Carboy, With Tubing and Clamp LDPE**

Heavy duty LDPE carboys with 5 ft. of Dynalon vinyl food grade tubing (610855 page 99). Sizes up to 1 gallon supplied with 1/4" I.D., 3/8" O.D. tubing, and use standard 15 position Dura-Clamp (670755 on page 38). Sizes 2 gal. and over take 1/4" I.D. x 5/8" O.D. tubing, with a 12 position Dura-Clamp™ (670725 on page 38) attached. Supplied with vented closures. Hose tubing can be clamped out of the way when not in use. Maximum temperature for LDPE is 80°C.

105674	-0001	-0002	-0006
Capacity gallon(s)	1	2	6 1/2
Height mm	330	419	24 1/2
Diameter mm	152	228	12
Pack Quantity	6	6	1
Pack Price \$	443.11	555.81	176.08



**NEW**

**NEW Carboy Spill Containment Tray and Lab Organizer**

- Designed for laboratory carboys or other large containers with spigots
- Trays are fabricated with 1/4" thick chemically resistant HDPE. All welded construction featuring a 1/2" skid resistant top shelf.
- Provides a safer way to dispense chemicals or other liquids in the lab
- Protects cabinets, laboratory benches and floors from liquid spills
- Each tray contains two convenient drain ports and 1/2" tubulation connection on lower trough
- Built-in lower bin for convenient storage of labware or accessories
- Built-in side handles for convenient transport
- 8" shelf height to accommodate up to a 5000mL beaker
- All trays are fabricated and tested in our Rochester, New York facility

Height: 13" / 330.2 mm  
Width: 24.5" / 622.3 mm  
Depth: 25" / 635 mm  
Shelf: 24"W x 12"D / 609 x 305 mm  
Tray (lower trough) capacity: 2 1/2 Gal / 10 L  
Weight: 16 lbs / 7.25 Kg

107364

Carboy Spill Tray

\$354.00 each

## Chiller - Container



### DQ Series DynaQube

*Most economic device to replace the ice bucket.*

An economical device that can take the place of an ice bucket! 2 year warranty.

The DynaQube keeps samples dry at low temperatures for long periods. Includes ceramic coated aluminum beads to accommodate various sample vials in a 75 x 75mm compartment.

5 Anodized Aluminium Blocks in 4 x 5 arrays are interchangeable and available as accessories to accommodate 0.2 to 2.0mL microtube vials.

There are two DynaQube models:

DQ-I, the analog device, maintains samples at 0°C.

DQ-II, with display and adjustable temperature setting maintains samples between 0°C and room temperature.



Temperature Range . . . . . 0°C to 4°C with no adjustment (DQ-01-01);  
room temperature to minus 5°C (DQ-01-02)  
Temperature Accuracy . . . ±1°C for DQ-01-02  
Cooling Technology . . . . . Peltier  
Power Supply Input . . . . . 90-230V, output 12V, 5A, 60 W  
Dimension mm . . . . . 188W x 188L x 158H (7.4" x 7.4" x 6.22")  
Weight . . . . . 2 KG (4.4 lbs)

DQ-01-01 Model DQ-I DynaQube, Analog\* \$411.45 each  
DQ-01-02 Model DQ-II DynaQube, digital Display\* and setting temperature mode \$514.57 each



### Anodized Aluminium Blocks

DQ-02-02B 32.5Hx75Lx75W w/ 20x inserts - 0.2ml vials \$113.43 each  
DQ-02-05B 32.5Hx75Lx75W w/ 20x inserts - 0.5ml vials \$113.43 each  
DQ-02-15B 32.5Hx75Lx75W w/ 20x inserts - 1.5ml vials \$113.43 each  
DQ-02-20B 32.5Hx75Lx75W w/ 20x inserts - 2.0ml vials \$113.43 each  
DQ-02-CB 32.5Hx75Lx75W w/ 20x inserts - combination vials 0.2, 0.5, 1.5 and 2.0 ml \$113.43 each  
DQ-02-20BDS Ceramic-Coated Aluminum Beads, pack/380gr \$28.36 each

\* Includes one (1) bag of ceramic coated aluminum beads, instructional manual (CD) and electrical cord.



670715

670755

670725

### Dura-Clamp® Tubing Flow Valve

- Easily operated with one hand
- One piece plastic construction – will not rust or corrode

	670715	670755	670725
Accepts Tubing OD	up to 1/4"	1/8" to 1/2"	up to 3/4"
Description	Mini, PP	Standard, PP	Maxi, Polyester
Case Quantity	100	25	6
Case Price \$	15.57	17.81	14.87



### Straight-Side Containers PP

Supplied with white polypropylene linerless screw closures. Made of translucent, autoclavable polypropylene. These jars are economical and ideal for storage of lab specimens, supplies or powders. Many industrial applications. Maximum temperature polypropylene is 121°C.

	421115	421125	421135	421145	421155
Capacity ml	30	60	120	250	500
Diameter mm	43	53	70	89	89
Height w/ cap mm	43	47	60	66	97
Case Quantity	72	48	36	36	24
Case Price \$	102.74	73.30	87.94	113.05	113.49

	421165	421185
Capacity ml	950	1200
Diameter mm	120	120
Height w/ cap mm	100	132
Case Quantity	24	24
Case Price \$	168.56	215.17



NEW



**NEW Straight-Side Containers PETE with White PP Closures**

Transparent Straight-Side Containers of PETE (Polyethylene Terephthalate) with white polypropylene liner less screw closures. Store pastes, samples, powders, specimens etc. in industrial and lab applications. PETE is durable, shatterproof and has excellent gas barrier properties with H<sub>2</sub>O, O<sub>2</sub> and CO<sub>2</sub>. These jars may be used below freezing to a maximum of 70°C.

426315	-0004	-0008	-0016	-0032
Capacity mL	125	250	500	1000
Diameter mm	73	73	93.5	92.4
Height with closure mm	46.4	79.5	86	173
Pack Quantity	12	6	6	6
Pack Price \$	28.80	18.30	25.92	39.60



**Straight-Side Polystyrene Containers**

Supplied with white polypropylene screw closures, these "glass-clear" polystyrene jars have many uses in the lab and industry. Lightweight and easy to fill. Maximum temperature polystyrene is 70°C.

	421205	421215	421195	421225	421235	421245
Capacity ml	60	120	180	240	480	1000
Diameter mm	53	70	70	89	89	120
Height w/ cap mm	47	60	72	66	97	100
Case Quantity	48	36	36	36	24	24
Case Price \$	72.31	84.15	96.07	108.43	102.53	156.98

**Small container sample pack available!  
Phone 800-334-7585 to request one.**



**Containers PP**

Molded of white opaque polypropylene, lightweight containers are not considered leak-proof. Many laboratory and industrial uses. Supplied with polypropylene screw closures. Maximum temperature PP is 121°C.

426325	-0025	-0050	-0100	-0200
Capacity ml	7.5	15	30	60
Diameter mm	28.5	37	38	49
Height mm	30	27	40.5	45
Closure mm	33	43	43	53
Case Quantity	144	144	144	72
Case Price \$	88.69	100.69	125.98	70.67

426325	-0400	-0800	-1600
Capacity ml	125	250	500
Diameter mm	65	85	84
Height mm	58	65	100
Closure mm	70	89	89
Case Quantity	72	48	36
Case Price \$	81.42	101.91	111.49



**Polystyrene Containers**

Rigid-wall styrene containers with tight fitting polyethylene snap-on caps. Excellent for storing dry materials, powders, tablets, etc. Approximately 16 drams per ounce. 7 dram size may be used with automatic cell counters for collection of sample and, where venous samples are used, for dilution purposes. Maximum temperature polystyrene is 70°C.

426364	-03	-05	-07
Capacity drams (mL)	3 (8)	5 (17)	7 (24)
I.D. mm	17	22	26
Height mm*	48	50	50
Case Quantity	144	144	144
Case Price \$	49.56	50.66	55.09

426364	-10	-13	-15
Capacity drams (mL)	10 (40)	13 (48)	15 (57)
I.D. mm	27	30	33
Height mm*	82	72	62
Case Quantity	144	144	144
Case Price \$	71.40	80.43	82.57

426364	-20	-30	-40
Capacity drams (mL)	20 (69)	30 (113)	40 (145)
I.D. mm	38	46	45
Height mm*	63	75	98
Case Quantity	144	72	72
Case Price \$	100.53	70.27	81.48

\*without cap

## Container



### Containers, Hinged Lid PE

These hinged lid containers are ideal for use just about anywhere. They feature a secure snap closure with hinged lid that eliminates lost caps. Containers offer air and moisture resistance to contents. Manufactured from flexible FDA approvable polyethylene resin.

226254	-0025	-0050	-1000	-1500	-2000	-4000
Capacity oz	.25	.5	1 flat	1	2	4
Height mm	13	19	25	38	41	86
Diameter mm	41	41	51	41	51	51
Case Quantity	100	100	100	100	100	100
Pack Price \$	37.09	41.50	57.27	57.43	67.73	89.15



### Container, Wide Mouth Lightweight HDPE

Wide mouth jar, molded of high density polyethylene with 100mm PP white cap. Light in

weight but strong and durable. Supplied in 1 gallon size only. Product dimensions (diameter x height): 6.5" x 10.5"

608735

\$112.76 pack of 12



### Cylindrical Jars with Screw Caps, HDPE

The cylindrical HDPE jars are supplied with insert and HDPE cap. Thanks to the large neck they are suitable for powders and solid specimens.

226415	-0070	-0120	-0250	-0500
Capacity mL	70	120	250	500
Diameter mm	50	56	69	86
Height mm	60	71	94	107
Pack Quantity	10	10	10	10
Pack Price \$	23.77	26.37	27.73	34.29

226415	-1000	-1500	-2000
Capacity mL	1000	1500	2000
Diameter mm	111	111	111
Height mm	128	182	235
Pack Quantity	10	10	10
Pack Price \$	45.28	52.32	59.35



**Kartell**

### Containers, Wide Mouth HDPE

Large, high density polyethylene utility jar with hundreds of uses around the lab. Wide mouth, natural color. Withstands temperatures to 110°C.

	626335	600335
Capacity gallons	1/2	1
Screw Cap mm	120	110
Height mm	160	254
Diameter mm	149	152
Closure mm	Polypropylene	Metal
Case Quantity	24	24
Case Price	95.09	171.94



**Translucent Round PP Containers with PP Lids**

- Easy to read imprinted graduations on the outside for inventory at a glance
- Round shape promotes proper air circulation around the container
- Molded-in holes in the handles for quick and sanitary drying
- Snap on covers fit tightly, yet can be easily removed; spill resistant
- Made of translucent material that is both durable and resistant to stains
- Withstands temperatures from -40°F to 160°F (-40°C - 70°C)
- FDA compliant

	454195	454205	454215	454225	454235
Capacity quart(s)	1	2	4	6	8
Top Diameter inches	6.0625	8.1875	8.1875	9.9375	9.9375
Height inches*	5	4.1875	8.5625	7.9375	10.875
Case Quantity	12	12	12	12	12
Case Price \$	100.03	108.54	122.73	154.65	192.96

\*Dimensions with cover



**Translucent PP Square Containers with HDPE Lids**

- Square shape means easy to store
- Easy-to-read graduations are printed on the outside for inventory at a glance
- Color-coded snap-tight HDPE covers (Kelly Green and Winter Rose) feature thumb tabs for easy removal
- Made of translucent material that is both durable and resistant to stains
- Withstands temperatures from -40°F to 160°F (-40°C - 70°C)
- FDA compliant

	451005	451025	451045	451065
Capacity quart(s)	2	4	6	8
Graduation Color	Green	Green	Rose	Rose
Length inches*	7.25	7.25	8.375	8.375
Width inches*	7.25	7.25	8.375	8.375
Height inches*	3.875	7.375	7.25	9.125
Case Quantity	6	6	6	6
Case Price \$	86.90	107.83	133.72	151.81

\*Dimensions with cover



**SEE  
spigots  
on page 84**

**Space Saver Container HDPE**

- 5 Liter
- Available with or without faucet

This rectangular HDPE bottle conveniently stores or dispenses 5 liters of liquid. Supplied with a standard closure, however the 38mm opening can also be secured with a dispensing faucet. Space saver bottle dimensions: 14 1/2"H x 9 1/4"D x 2 1/2"W.

	405644	405654	405684
Description	Bottle	Faucet	Bottle with Faucet
Capacity liter(s)	5	NA	5
Pack Quantity	12	12	12
Pack Price \$	143.84	55.55	202.98



**Translucent PP Pans with PP Lids**

- Translucent thick walled polypropylene material allows for content visibility
- Withstands autoclaving
- Non-stick smooth interior surface increases yield and eases cleaning

	426444	-0002	-0004	-0006	-0008
Capacity quart(s)	2.4	3.9	5.6	9.4	
Length inches	6.9375	10.4375	12.75	12.75	
Width inches	6.375	6.375	6.9375	10.4375	
Pan Depth inches	6	6	6	6	
Case Quantity	6	6	6	6	
Case Price \$	111.02	115.99	138.33	174.51	

## Container - Crucible



### Disposable Specimen Containers, HDPE and PCO with LDPE Lids

- Choose either translucent or opaque containers
- Maximum temperature HDPE 110°C

Containers are HDPE except 8, 16, 32 oz natural and white, and 83 oz natural, which are PCO, a copolymer of Polypropylene and High Density Polyethylene. PCO offers a product with a higher temperature range while maintaining good impact strength. Recycling code is "5" for PP and the HDPE recycling code remains "2".

#### WHITE OPAQUE DISPOSABLE SPECIMEN CONTAINERS

	454395	454405	454415	454425	454435	454445
Capacity ml	120	240	480	960	2000	4800
Capacity oz.	4.2	7.7	15.5	34.5	70.1	168.8
Material	HDPE	PCO	PCO	PCO	PCO	HDPE
O.D. inches	3.2	3.1	3.6	4.6	5.9	8.1
Height inches*	1.8	3.5	4.0	5.3	6.6	7.8
Case Quantity	250	250	100	100	50	25
Case Price \$	153.20	147.87	72.62	120.97	113.49	107.84

#### ASSORTED DISPOSABLE SPECIMEN CONTAINER KIT

454455 Contains:	454395	454405	454415	454425	454435	454445
Quantity	25	20	20	20	10	5
Kit Price 100 Containers \$	102.17					

Both natural and white lids, all sizes, are made of LLDPE. Linear Low Density Polyethylene is tough like LDPE and a bit more rigid like HDPE, thereby allowing for a tight fitting lid. Recycling code is 4. Designed to simplify and standardize the handling and storage of specimens. The containers are inert and cannot be attacked by formaldehyde or weak acids or bases. Will resist freezing or boiling. They have long shelf lives and are easily disposable. Sturdy enough for reuse. Easy to store, requires little space. Price includes container with lid.

#### NATURAL DISPOSABLE SPECIMEN CONTAINERS

	453565	453595	453595L	453605
Capacity ml	120	240	240	480
Capacity oz.	4.2	7.7	7.7	15.5
Material	HDPE	PCO	PCO	PCO
O.D. inches	3.2	3.1	4.875	3.6
Height inches*	1.8	3.5	1.875	4.0
Case Quantity	250	250	250	100
Case Price \$	146.06	147.16	154.68	75.73

#### 

	453615	453625	453555	453635
Capacity ml	960	2000	2200	4800
Capacity oz.	34.5	70.1	83.6	168.8
Material	PCO	PCO	PCO	HDPE
O.D. inches	4.6	5.9	6.4	8.1
Height inches*	5.3	6.6	6.6	7.8
Case Quantity	100	50	25	25
Case Price \$	120.16	105.43	68.06	114.86

\*Dimensions with lid



### Crucibles PTFE

Chemically inert and useable to 280°C. Machine finished surfaces for ease of cleaning and to eliminate contamination.

	355004	355014	355024	355034
Capacity ml	5	25	75	100
Diameter mm	16	26	41	46
Height mm	27	44	56	71
Price Each \$	13.10	19.01	30.60	36.17

## Cutting Board - Cuvette Accessories

\*\*\* CUT TO SIZE - CALL FOR DETAILS \*\*\*



### Cutting Board HDPE

White, easy-to-clean surface. Provides excellent surface for examining specimens, cutting, dissecting, etc. NSF, FDA and USDA approved material. [Additional sizes and materials available upon request.](#)

	116405	116415	116425	116435	116445
Length inches	12	15	18	18	11.75
Width inches	18	20	24	24	7.75
Height inches	0.5	0.5	0.5	0.75	0.5
Price Each \$	34.21	48.73	67.71	95.82	59.30

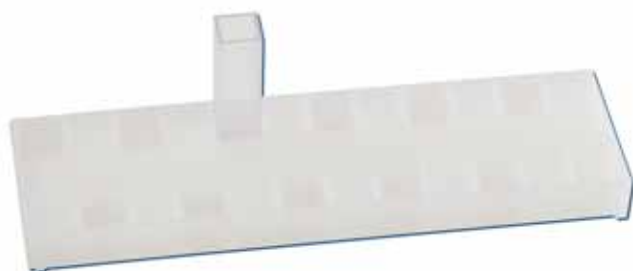

### Cuvette Holder LDPE

Holds 12 glass, silica, or plastic disposable cuvettes (external dimensions 12.5 x 12.5 mm). Permits easy viewing of the solution color to be measured and helps prevent breakage. The cuvettes can also be fitted horizontally in the base after usage for storing purposes. Dimensions: 170mm L x 70mm W x 15mm H (6 11/16" x 2 3/4" x 3/8").

202215

Cuvette Holder

\$23.92 pack of 5

**Kartell**



### Cuvette Stirring Spatulas

Polystyrene disposable Cuvette Stirring Spatulas measure 120mm long by 3mm diameter. Packed 500 stirrers in a polyethylene bag, 2 bags (1000 stirrers) per case.

375985

Disposable Cuvette Stirrers

\$47.76 per case



### Cuvette Caps LDPE

Polyethylene dust covers fit most standard cuvettes. Flexible fins on cap allow for tight fit that will not damage the cuvette. Caps are 19mm in depth. Supplied in cases of 1000 caps.

402364

Cuvette Caps

\$97.01 per case

## Highest Quality Disposable Cuvettes Available

**Extra advantages only from Dynalon...** The extra advantage from Dynalon cuvettes is superior optical and surface qualities at economical prices. Affording your laboratory the convenience of disposable cuvettes, without sacrificing accuracy or precision of standard cuvettes. Disposable means you save time with no cleaning required, plus the extra safety advantage of preventing cross contamination. Dynalon uses the most technologically advanced toolmaking process. This means reduced dimensional tolerances to ensure the lowest variation of extinction coefficient within the package.

Each cuvette features an impression number, use cuvettes with the same impression number for optimal precision between samples. Each case consists of cuvettes with the same impression number. Dust-Proof Scratch Resistant Packaging...All cuvettes feature stackable trays with covers of expanded polystyrene (CFC-free) to meet today's manufacturing pollution standards. Unique tray packaging is easy to store and protects optical surfaces from scratches.

**SEE cuvettes on pages 44-45**

## Cuvette Specifications

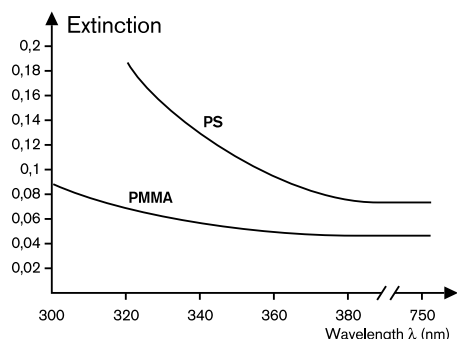

Typical values for macro and semi-micro cuvettes. Measured with water at 20°C, against air (E=0).

<b>Material</b>	Polystyrene (PS) Polymethyl methacrylate (PMMA)
<b>Filling Volume</b>	Macro cuvette: minimum 2.5ml; maximum 4.5ml Semi-micro cuvette: minimum 1.5ml; maximum 3.0ml
<b>Dimensions</b>	Cuvette: 12.5 x 12.5 x 45mm, light path 10mm Windows: Macro 10 x 35mm Semi-Micro 5 x 23mm

PS cuvettes have a typical range of application from 340nm. Standard deviation at 360nm  $\leq \pm 0.005$  extinction units. PMMA cuvettes have a typical range of application from 300nm. Standard deviation at 320nm  $\leq \pm 0.004$  extinction units.



### Cuvettes, Visible Range Semi-Micro, 1.5ml

These exceptionally fine quality polystyrene cuvettes are designed for assays throughout the 340nm to 750nm visible spectral range. A standard 1cm light path and recessed windows provide maximum light transmission. Scale down your assay volumes to save on costly reagents using these specially designed cuvettes that have a minimum filling volume of 1.2ml. Packaged 100 per covered tray, with 500 per case. Dimensions: 12.5 x 12.5 x 45mm. Windows: 5 x 23mm. Light Path: 10mm.

302205-0002 \$104.64 per case

### Cuvettes, UV-VIS Range Semi-Micro, 1.5ml

Injection molded from a superior grade of methacrylate designed for accuracy throughout the VIS-UV spectral range from 285nm to 750nm. Excellent optical qualities

throughout the spectral range make these cuvettes perfect for scanning small volumes, enzyme rate reactions, and standard curve determinations. Packaged 100 per covered tray, with 500 per case.

302225-0002 \$117.87 per case



### Cuvettes, Visible Range Macro, 4.5ml

These exceptionally fine quality polystyrene cuvettes are designed for assays throughout the 340nm to 750nm visible spectral range. These specially designed cuvettes handle up to 4.5ml total volume with minimum filling volume of 2.5ml and a maximum of 4.5ml. Molded arrow indicates the direction of transmission for optimal signal and reproducibility. Packaged 100 per covered tray, with 500 per case. Dimensions: 12.5 x 12.5 x 45mm. Window: 10 x 35mm. Light Path: 10mm.

302195-0002 \$101.16 per case

### Cuvettes, UV-VIS Range Macro, 4.5ml

A superior grade of methacrylate provides an excellent degree of light transmission throughout the VIS-UV spectral range from 285nm to 750nm. These cuvettes are ideal

for scanning, enzyme rate reactions (with small delta absorbances), and standard curve determinations. These cuvettes have a minimum filling volume of 2.5ml and a maximum of 4.5ml. Packaged 100 per cover ed tray, with 500 per case.

302235-0002 \$138.99 per case



**Cuvette sample packs available, phone 800-334-7585 to request one.**

### Cuvettes, 4 Clear Sides Macro 4.5ml

Designed specifically for fluorometry, this is an excellent choice for nephelometry and spectrophotometry. A negligible variation in absorbance between the 4 optical sides allows readings from any side. The polystyrene cuvettes are accurate in the 340nm to 750nm visible spectral range. The methacrylate cuvettes are accurate throughout the 285nm to 750nm VIS-UV spectral range. Standard 1cm light path. Packaged 100 per covered tray, with 500 per case. Note: 4 Clear-Sided Cuvettes not sorted by nest numbers.

202295 VIS Macro Cuvettes \$87.71 per case  
202285 UV-VIS Macro Cuvettes \$115.77 per case

**Kartell**



**UV-Cuvette Micro, UV-Transparent Cuvettes**

- Specially designed for photometric determination of proteins, ssDNA, dsDNA, RNA and oligonucleotides in the UV range
- Ideally suited for measurements at 260 nm, 280 nm and in the visible range
- Standard 10 mm light path
- No need for cleaning, no associated risk of sample carryover or cross-contamination
- Sample volumes as small as 70 µl are sufficient
- 15 mm center height allows use without adapter in most commercial spectrophotometers: Amersham Biosciences, Analytik Jena, Biochrom, WPA, Eppendorf®, Perkin Elmer Instruments™, Techné, ThermoSpectronic, etc.

UV-transparent disposable cuvettes replace expensive, fragile quartz cuvettes and are excellent for DNA, RNA, and protein analysis between 220-900nm. Resistant to many aggressive solvents, they eliminate the tedious maintenance, cleaning, and contamination of quartz cuvettes. Packaged 100 per pack.

- 302425-0001 UV-Cuvettes, ultra-micro, 15mm window \$82.32 PK
- 302425-0002 UV-Cuvettes, ultra-micro, 8.5mm window \$84.00 PK
- 302375-0000 Ultra-micro cuvette caps, blue, PE \$29.56 PK



**SEE  
cylinder drying racks  
on pages 55 - 56**



**ISO 9001 Certified Graduated Cylinders PMP**

- Accuracy is individually checked
- Complete with Certificate of Accuracy (25mL through 2L sizes)
- Safer, more economical than glass
- Shatter resistant - reduce breakage & incidence of injury!
- Chemically resistant to most acids, bases and many common solvents

Dynalon®, plastic, premium graduated cylinders are manufactured under strict control. Each cylinder is manually checked and marked with an “H” to confirm premium tolerance has been achieved. These cylinders are manufactured from virgin PMP (polymethylpentene) to provide window-clear transparency and outstanding chemical compatibility. PMP can be sterilized using all common methods including autoclaving\*.

Safety first...Plastic cylinders will not shatter like glass. They are the ideal replacement for glass cylinders in production environments where broken glass would contaminate production, i.e. food and beverage production, pharmaceutical, chemical and semiconductor industries. Replacement costs due to breakage are also greatly reduced. Each cylinder (except the 10mL) is supplied complete with certificate. \*Repeated autoclaving will affect accuracy.

338005	-0010	-0025	-0050	-0100	-0250
Capacity ml	10	25	50	100	250
Sub Divisions ml	0.2	0.5	1	1	2
Diameter mm	16	21	28	34	47
Height mm	140	169	199	260	315
Tolerance +/- ml	0.2	0.5	1	1	2
Case Quantity	12	8	8	6	6
Case Price \$	191.61	155.43	153.39	136.84	226.89

338005	-0500	-1000	-2000
Capacity ml	500	1000	2000
Sub Divisions ml	5	10	20
Diameter mm	61	76	97
Height mm	350	415	482
Tolerance +/- ml	5	10	20
Case Quantity	4	4	2
Case Price \$	220.95	354.00	235.06

# Cylinder



237735 - 237915



239005 - 239075

## Economy Molded Cylinders PP & PMP

- Durable molded graduations
- Shatter resistant - reduce breakage & incidence of injury!
- Chemically resistant to most acids, bases and many common solvents
- Autoclavable
- Choose glass-like clarity of polymethylpentene (PMP) or
- Choose economical translucent polypropylene (PP)

These cylinders feature permanently molded graduations that will not fade after repeated autoclaving. Meets stringent international quality criteria according to ISO 6706 standards. Tolerances according to DIN 12 680 TT, Class B. Maximum temperature: PP 121°C, PMP 135°C

	237735	237745	237755	237765	237775	237885	237895	237915
Material	PMP	PMP	PMP	PMP	PMP	PMP	PMP	PMP
Capacity ml	10	25	50	100	250	500	1000	2000
Sub Divisions ml	0.2	0.5	1	1	2	5	10	20
Diameter mm	14	20	26	31	42	55	66	83
Height mm	140	170	200	250	315	360	440	535
Tolerance +/- ml	0.2	0.5	1	1	2	5	10	20
Case Quantity	20	20	20	10	8	6	4	4
Case Price \$	108.82	127.16	161.45	96.68	96.51	95.90	79.56	195.79

	239005	239015	239025	239035	239045	239055	239065	239075
Material	PP	PP	PP	PP	PP	PP	PP	PP
Capacity ml	10	25	50	100	250	500	1000	2000
Sub Divisions ml	0.2	0.5	1	1	2	5	10	20
Diameter mm	14	20	26	31	42	55	66	83
Height mm	140	170	200	250	315	360	440	535
Tolerance +/- ml	0.2	0.5	1	1	2	5	10	20
Case Quantity	20	20	20	10	10	8	6	4
Case Price \$	102.53	113.12	157.28	86.65	99.86	115.74	106.04	140.11

	239085	-0000	-0001	-0002
Material		PP	PP	PP
Consists of Capacities ml		10, 25, 50, 100, 250, 500, 1000	10, 50, 100, 250, 500, 1000	10, 50, 100, 500, 1000
Price Each \$		74.43	68.27	57.46



## Conical Graduate PP



- Withstands temperatures to 121°C

These polypropylene graduates have a wide base for stability and are designed for safe grip. Highly resistant to chemicals. Autoclavable.

	212205	212215
Capacity ml	100	250
Increments ml	2	5
Top Diameter mm	65	88
Height mm	120	160
Tolerance +/- ml	0.2	0.5
Case Quantity	6	6
Case Price \$	51.03	80.60

	212225	212235
Capacity ml	500	1000
Increments ml	10	20
Top Diameter mm	103	148
Height mm	180	270
Tolerance +/- ml	1	1
Case Quantity	6	6
Case Price \$	82.00	170.49



Dynalon® Labware





**Drying Rack, High Impact Polystyrene** **Kartell**

- Expandable, fasteners to connect additional racks included
- Interchangeable, removable pegs

This 72 place drying rack is molded of high impact polystyrene. It comes supplied with 72 large pegs, draining tubes, fastening stoppers, and expansion hanging hooks which allow coupling with additional racks. The pegs are 4" long and the drip ledge measures 3".

	<b>259184</b>
Description	Drying Rack
Width inches	17
Height inches	24
Price Each \$	268.41

<b>259194</b>	
Bag of 11 Test Tube Pegs	\$22.44



**537815 series**



**537805 series**

**Printed Cylinders PP & PMP**

- Brilliant easy to read blue printed graduations
- Shatter resistant - reduce breakage & incidence of injury!
- Chemically resistant to most acids, bases and many common solvents
- Autoclavable
- Choose glass-like clarity of polymethylpentene (PMP) or
- Choose economical translucent polypropylene (PP)

These cylinders feature permanently easy to read blue screened graduations that resist fading and scratching after repeated autoclaving. Meets stringent international quality criteria according to ISO 6706 standards. Tolerances according to DIN 12 680 TT, Class B. Maximum temperature: PP 121°C, PMP 135°C

<b>537805</b>	<b>-0010</b>	<b>-0025</b>	<b>-0050</b>	<b>-0100</b>	<b>-0250</b>	<b>-0500</b>	<b>-1000</b>	<b>-2000</b>
Material	PMP	PMP	PMP	PMP	PMP	PMP	PMP	PMP
Capacity ml	10	25	50	100	250	500	1000	2000
Sub Divisions ml	0.2	0.5	1	1	2	5	10	20
Diameter mm	14	20	26	31	42	55	66	83
Height mm	140	170	200	250	315	360	440	535
Tolerance +/- ml	0.2	0.5	1	1	2	5	10	20
Case Quantity	20	20	20	10	8	6	4	4
Case Price \$	134.33	156.93	199.32	119.38	119.17	118.37	98.23	241.71

<b>537815</b>	<b>-0010</b>	<b>-0025</b>	<b>-0050</b>	<b>-0100</b>	<b>-0250</b>	<b>-0500</b>	<b>-1000</b>	<b>-2000</b>
Material	PP	PP	PP	PP	PP	PP	PP	PP
Capacity ml	10	25	50	100	250	500	1000	2000
Sub Divisions ml	0.2	0.5	1	1	2	5	10	20
Diameter mm	14	20	26	31	42	55	66	83
Height mm	140	170	200	250	315	360	440	535
Tolerance +/- ml	0.2	0.5	1	1	2	5	10	20
Case Quantity	20	20	20	10	10	8	6	4
Case Price \$	126.55	139.65	194.16	106.97	123.29	137.19	130.91	172.92

**Hydrometer Jar - Cylinder PP**

Translucent polypropylene 500 ml cylinder with overflow cup. Molded graduations. Overall dimensions: 1" I.D. x 12" high (38 x 305mm). Base is 4 1/4" (108 mm) in diameter. Additional sizes upon request.

141805                      \$48.24 each

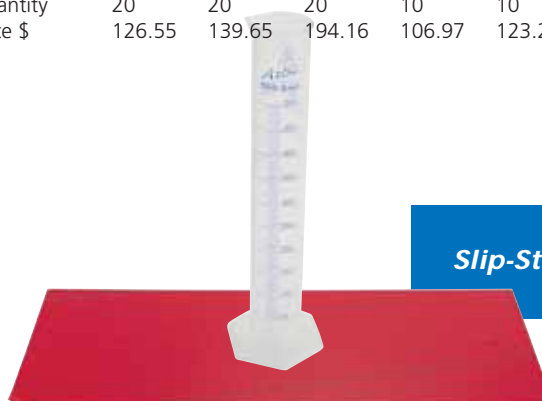

**SEE**  
**Slip-Stop anti-slip matting**  
**on page 67**

## Cylinder, Squat - Delivery Tube



### Cylinders, Squat Form, Polypropylene

- Squat design for increased stability on the bench and ease of handling particularly in restricted spaces
- Self-draining base eliminates water collection during washing in an automatic lab washing machine - thereby removing all spill re-wetting and contamination issues
- Clear molded blue over-printed graduations - always visible
- High clarity polypropylene - safe, unbreakable with good chemical and temperature resistance
- Anti suction base - no problems when working on wet surfaces
- Space saving storage with low form cylinder design

*Azlon*

The squat design makes these translucent polypropylene products more stable on the bench than traditional glass or plastic cylinders and results in fewer spills or more serious accidents. They are easier to handle, particularly in confined spaces such as fume hoods. The lower form means you require less overhead storage space. Not only are the graduations molded into the product, but they are also overprinted in attractive Azlon blue ink. And these cylinders have a unique self draining base that will allow wastewater to drain when inverted in a dishwasher - a first from Azlon!

537835	-0100	-0250	-0500	-1000
Capacity mL	100	250	500	1000
Graduations mL	2.0	5.0	10.0	20.0
Tolerance +/- mL	2.0	5.0	10.0	20.0
Diameter mm	39	54	68	80
Height mm	160	190	215	282
Case Quantity	5	1	1	1
Case Price \$	49.50	13.24	17.12	22.40



**SEE  
cylinder drying racks  
on pages 55 - 56**



### Cylinder Polypropylene 4 Liter

- Calibrated TC/TD In 20°C +/- 50mL
- Height w Base: 23 1/2"
- Subdivisions: 50mL
- Weight: less than 11 lbs when full to 4 L
- Compliant with US FDA 21 CFR 177.1520 for use with Food and Beverage
- Compliant with ISO 6706

A 4 Liter translucent polypropylene Cylinder in a Squat Format with graduations marked in blue print. 50mL increments with 500mL graduation lines printed around circumference. Less than 24" in height with stable 8" diameter octagonal base. The base unscrews from cylinder for ease of cleaning and storage. Use for measuring large volumes, mixing and making up solutions and buffers. Complies with ISO 6706 and US FDA 21 CFR 177.1520 for use with Food and Beverage. Autoclavable (repeated autoclaving may affect accuracy).

537835-4000

\$199.47 each

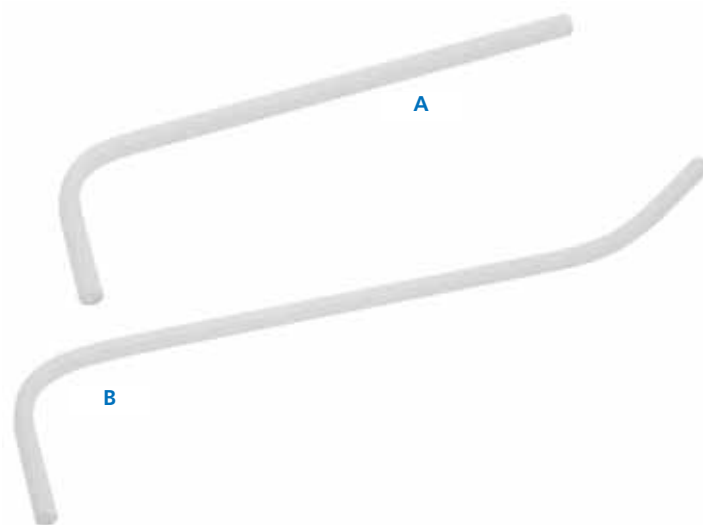

### Delivery Tubes, Polypropylene

- Eliminate cuts caused by fragile glass alternatives
- Pre-bent rigid Polypropylene delivery tubes
- Unbreakable in normal use
- Suitable for many types of gas collection experiments  
6mm OD fits 5mm stopper holes
- Available in three configurations

*Azlon*

510864	-0001	-0003
Photo Reference	A	B
External Diameter mm	6	6
Internal Diameter mm	4	4
Pack Quantity	5	5
Pack Price \$	37.60	37.60



**Desiccator Cabinets Acrylic**

For dry, dust-free storage at temperatures up to 120°F for use in incubators, freezers, refrigerators, or at room temperature. Cabinets have air-tight doors that need no lubrication. Sliding perforated shelves for easy access; transparent acrylic walls, for see-thru storage. A third bottom shelf accommodates desiccants.

Cabinets also available with locks and Hygrometer. Hygrometer has a temperature range of -58° to 158°F with +/-1.8°F accuracy up to 104°F. Humidity range is 20 to 95% with +/-5% accuracy. LCD display. Includes 2 AAA batteries. [Additional sizes available upon request.](#)

**Nitrogen Purge Cabinet Acrylic**

Simple, easy to use at temperatures up to 120°F for use in freezers, refrigerators, or at room temperature. Cabinets have air-tight doors that need no lubrication. Sliding perforated shelves for easy access; transparent acrylic walls, for see-thru storage.

Cabinets also available with Flow Meters. Direct reading scale flow meters with control valve let you not only measure flow through the meter, but also make flow adjustments in the line. Acrylic, ethylene polypropylene and Type 316 stainless steel wetted parts. Flow range: 2-20 scfh with accuracy of +/-6%. Flow meter dimensions: 2" scale height x 4 1/8" overall height with mounting centers of 3". [Additional sizes available upon request.](#)

**DESICCATOR CABINETS ACRYLIC**

	143105	143115
Description	Regular	Regular
Length inches	10	16
Width inches	7	9
Height inches	8 1/2	10 1/2
Price Each \$	348.09	441.00

	143105-0001	143115-0001
Description	w/ Hygrometer	W/ Hygrometer
Length inches	10	16
Width inches	7	9
Height inches	8 1/2	10 1/2
Price Each \$	553.36	631.13

**LOCKING DESICCATOR CABINETS ACRYLIC**

	143084	143094
Description	Regular	Regular
Length inches	10	16
Width inches	7	9
Height inches	8 1/2	10 1/2
Price Each \$	436.37	514.14

	143084-0001	143094-0001
Description	w/ Hygrometer	W/ Hygrometer
Length inches	10	16
Width inches	7	9
Height inches	8 1/2	10 1/2
Price Each \$	627.13	704.93

	143134	143144
Description	Regular	Regular
Length inches	10	16
Width inches	7	9
Height inches	8 1/2	10 1/2
Price Each \$	416.82	591.42

	143134-0001	143144-0001
Description	With Flow Meter	With Flow Meter
Length inches	10	16
Width inches	7	9
Height inches	8 1/2	10 1/2
Price Each \$	494.62	669.22



*All cabinets on this page are fabricated in our Rochester, NY facility and can be customized to your special requirements.*

## Desiccator - Dippas™



### Desiccator and Desiccator Plates

- Polycarbonate cover takes 8-10mm tubing
- Polypropylene base and plates

Unbreakable vacuum-desiccator holds a vacuum of 740 mm of mercury (29") for 24 hours. A neoprene "O" ring in groove of bottom section gives an excellent seal with upper section. The vacuum retention valve (not barbed) allows air to enter slowly to prevent damage to the samples inside. Removable pan holds calcium chloride or other drying agents and is non-corrosive.



**Kartell**

	243025	243045	243065
Flange O.D. mm	171	234	285
Flange O/D/ inches	6 3/4	9 1/4	11 1/4
Inside Diameter mm	149	198	147
Inside Diameter inches	5 7/8	7 3/4	9 3/4
Overall Height mm	190	241	292
Overall Height inches	7 1/2	9 1/2	11 1/2
Takes Plate	256025	256045	256065
Case Quantity	4	4	4
Case Price \$	303.49	453.39	565.75

DESICCATOR PLATES	256025	256045	256065
Plate Diameter mm	141	190	239
Fits Desiccator Above	243025	243045	243065
Case Quantity	10	10	10
Case Price \$	185.25	200.41	233.31



### "Dippas™" Sterile PS

- Dippas are designed for sample collection and despatch from one source, thus eliminating the risk of cross contamination
- Dippas are available in transparent polystyrene or shatterproof polypropylene
- Handles are easily removable, facilitating transport
- All dippas are supplied sterile by irradiation and are individually wrapped to ensure complete sterility
- Blue dippas are highly visible in product samples  
If accidentally dropped in a vat of aqueous liquid polypropylene dippas will surface for easy retrieval

507054	-0030	-0100	-0250	-B030	-B100	-B250
Description	Clear	Clear	Clear	Blue	Blue	Blue
Handle Length mm	200	385	330	200	385	330
Capacity ml	30	100	250	30	100	250
Cap Material	PP	METAL	METAL	PP	METAL	METAL
Height mm	93.1	76.4	120.6	93.1	76.4	120.6
Diameter mm	30.1	50.5	65.1	30.1	50.5	65.1
Case Quantity	50	100	50	50	100	50
Case Price \$	109.45	327.50	208.33	116.00	329.12	213.61



### Lipsol® Detergent, Concentrate

- Free of chlorine bleaches phosphate and enzyme free
- Suitable for laboratory medical and industrial applications
- Not suitable for use on non-ferrous metals especially aluminum or zinc
- Not suitable for use on polycarbonate

**Azlon**

With a cleaning performance second to none, new Lipsol marks the arrival of the next generation of laboratory detergent. Lipsol is a non-corrosive, fully biodegradable liquid concentrate, suitable for use with all types of laboratory glassware, ceramics, plastics, rubber, stainless steel and ferrous metals. Lipsol is a highly alkaline mixture of detergent, surfactant and chelating agent suitable for removal of most types of contamination by soaking or use in an ultrasonic bath; **not for use in dishwasher.**

Its efficiency as a cleaning agent has been proved by extensive testing and then confirmed by field trials with users in a wide variety of applications and scientific disciplines. Lipsol is classified as a non-CORROSIVE. Free supporting independent test reports are available on request as is a MSDS.

504004

\$106.76 case of 2

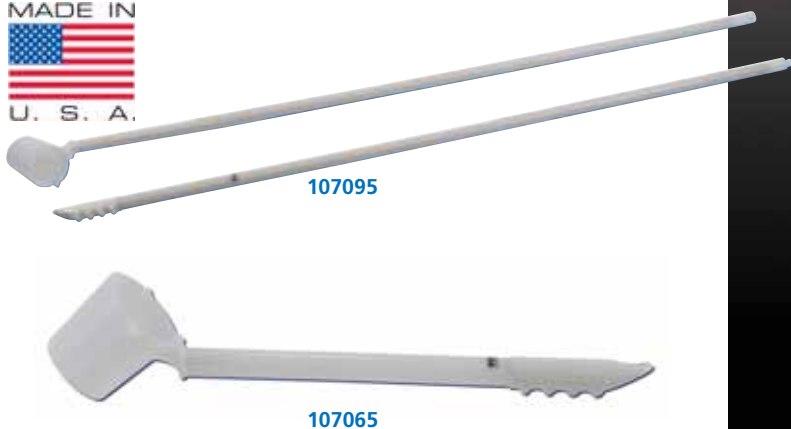

**Dippers HDPE**

- Graduated
- PVC hand grip
- 2 Pour spouts
- 500ml & 1000ml beaker

High density polyethylene dipper for removing samples from large tanks. Lightweight but durable. Available in seven popular sizes. 500mL capacity dippers feature graduation markings of 50ml and 1000mL is graduated in increments of 100mL. \*12-foot size supplied with 2-piece handle for economy in shipping and storage. [Additional sizes available upon request.](#)

	107065	107075	107085	107095
Handle Length feet	1.5	3	6	12*
Capacity ml	500	500	500	500
Price Each \$	31.73	39.86	57.59	113.85

	106505	106515	106525
Handle Length feet	3	6	12*
Capacity ml	1000	1000	1000
Price Each \$	56.78	69.37	116.47



**SEE drum and liquid samplers on page 78**

**Dippers PTFE**

Totally inert and non-contaminating. Extendible screw-in shafts have a steel core for rigidity and are fully encapsulated in PTFE. The basic unit consists of a beaker with a single 24" (600mm) shaft.

	-0100	-0250	-0500	-1000
Capacity ml	100	250	500	1000
Body Diameter mm	54	66	80	100
Shaft Length mm	600	600	600	600
Price Each \$	152.79	169.13	204.30	266.40

307024-HAND Replacement screw-on handle \$95.89 each

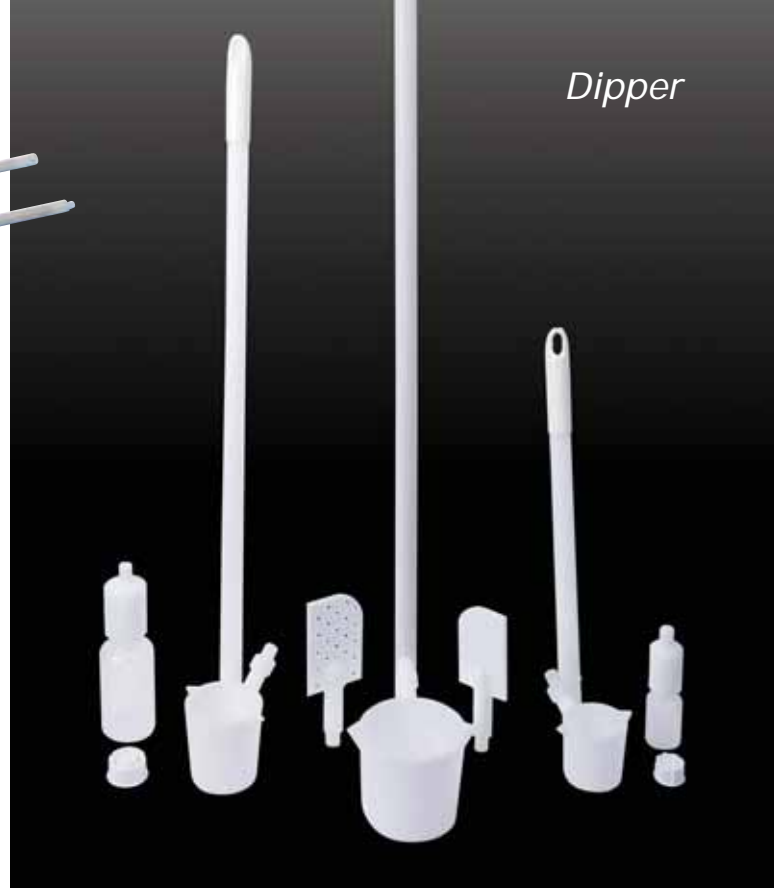

**Liquid Sampling & Stirring Kit, HDPE**



- FDA Compliant HDPE
- Purchase individual components or as an entire kit
- Dipper kit includes 3 convenient handle lengths and 3 popular beaker capacities
- Stirrer kit includes 3 convenient handle lengths and two paddle heads
- Sampling kit includes 3 convenient handle lengths and 2 popular bottle capacities
- Mega kit includes 3 convenient handle lengths and all beaker, paddle and sampler options

Dynalon's new versatile modular liquid handling series fits all your needs. Whether sampling from drums or rail cars, stirring vats or dipping chemicals from a bath... we have the configuration to fill your requirements. Components are available piecemeal, as intuitive kits or buy the entire mega kit to cover all your bases. Inter changeable threaded components make using this product line quick, fun and easy!

Catalog Number	Description	UOM	Price
107035-1000	Dipper Sampling Kit (1 each below)		\$209.26
107035-0001	1.5' Handle	EA	35.89
107035-0002	3' Handle	EA	43.72
107035-0003	6' Handle	EA	55.27
107035-0004	250mL Dipping Beaker	EA	31.43
107035-0005	500mL Dipping Beaker	EA	32.46
107035-0006	1000mL Dipping Beaker	EA	38.90
107035-2000	Stirrer Kit (1 each below)		\$174.25
107035-0001	1.5' Handle	EA	35.89
107035-0002	3' Handle	EA	43.72
107035-0003	6' Handle	EA	55.27
107035-0007	Stirring Paddle	EA	23.55
107035-0008	Perforated Mixing Paddle	EA	35.18
107035-3000	Liquid Sampler Kit (1 each below)		\$259.86
107035-0001	1.5' Handle	EA	35.89
107035-0002	3' Handle	EA	43.72
107035-0003	6' Handle	EA	55.27
107035-0009	Sampler with Bottle 100mL	EA	62.53
107035-0010	Sampler with Bottle 500mL	EA	91.32
107035-5000	Complete Liquid Sampling & Stirring Kit (Consists of 1 each above -0001 to -0010)		\$378.34

## Dipping Basket



146644

146564



### Round Dipping Baskets HDPE/PP

HDPE fabricated dipping baskets are made with 1/8" thick walls, 3/16" diameter perforations on 5/16" centers. Made from high density polyethylene. Takes 140°F on a continuous basis or more for shorter periods (up to 160°F). Supplied with sturdy swinging handle—a unique feature allowing easy storage and loading. All have perforated bottoms. Polypropylene fabricated dipping baskets withstands 180°F on a continuous basis or up to 200°F for shorter periods. Excellent chemical resistance. Supplied with swinging handle. Perforations 1/8" diameter on 21/64" center. [Additional sizes available upon request.](#)

	146554	146564	146574	146584	146594
Material	HDPE	HDPE	HDPE	HDPE	HDPE
Diameter inches	6	8	8	10	12
Height inches	6	8	10	10	12
Price Each \$	133.80	153.84	180.74	196.21	210.31

	146604	146614	146624	146634	146644
Material	PP	PP	PP	PP	PP
Diameter inches	6	8	8	10	12
Height inches	6	8	10	10	12
Price Each \$	149.27	159.54	180.74	184.08	220.94

### Mini Dipping Baskets PP

Autoclavable polypropylene basket is perfect for dipping very small parts. Excellent chemical resistance allows for use with acids. Continuous use temperature up to 180°F. Openings in mesh are .120" x .165" with 37% open area. Ring around top acts as a handle and works as a rest when used with tongs. [Additional sizes available upon request.](#)

146534	-0001	-0002
Diameter inches	4	4
Height inches	16	7
Price Each \$	113.98	108.20

*All dipping baskets on this page are fabricated in our Rochester, NY facility and can be customized to your special requirements.*



### Dipping Baskets with Tanks

Low density polyethylene tanks with covers and specially fabricated Polypropylene dipping baskets with perforated bottom and sides to fit in tanks. Polypropylene dipping baskets have strap handle.

#### DIPPING BASKETS SUPPLIED WITH TANKS

	126164	126174	126184	126194
Tank Capacity gallons	3	4 1/2	6	10
Tank Top Diameter inches	11 1/2	12 1/2	13	15 1/2
Tank Bottom Diameter inches	9 1/2	10 1/2	11	13 1/2
Tank Height inches	11	10 1/2	16	18
Basket Diameter inches	8	9	9	11 1/2
Basket Height inches	8	10	13	17
Price Each \$	208.34	247.09	277.35	335.81

LDPE TANKS WITH COVERS	625044	625084	625124	625164
Shown above in System	126164	126174	126184	126194
Price Each \$	103.59	91.44	115.56	121.88

PP DIPPING BASKETS	167174-20	167174-30	167174-50	167174-70
Shown above in System	126164	126174	126184	126194
Price Each \$	153.70	199.26	210.74	273.19

## Dipping Basket



**Rectangular Dipping Baskets PP & HDPE**

- Sturdy swivel handle
- Perforated sides and bottoms

Fabricated of either heat resistant polypropylene with 1/8" thick walls, 1/8" diameter perforations on 21/64" centers with 1/4" top and bottom support flange or fabricated of high density polyethylene with 1/8" thick walls, 3/16" diameter perforations on 5/16" centers. Convenient rectangular shape easily fits into standard tanks. Excellent for washing, pickling or dipping into corrosive liquids. Supplied with perforated bottoms and sides and ends. Polypropylene will withstand continuous use at 135°C; HDPE at 120°C. *Additional sizes and/or solid bottoms available upon request.*

	146764	146784	146684	146704
Material	PP	PP	HDPE	HDPE
Length inches	8	12	8	12
Width inches	10	12	10	12
Height inches	10	12	10	12
Price Each	210.31	243.14	179.58	212.38

**Rectangular Dipping Baskets HDPE**

Fabricated of high density polyethylene with 1/8" thick walls, 3/16" diameter perforations on 5/16" centers. Convenient rectangular shape easily fits into standard tanks. Excellent for washing, pickling or dipping into corrosive liquids. Supplied with perforated bottoms and sides and solid ends. *Additional sizes and/or solid bottoms available upon request.*

	146814	146824
Length inches	12	18
Width inches	8	12
Height inches	6	9
Price Each \$	159.01	229.41

*Both series of dipping baskets above are fabricated in our Rochester, NY facility and can be customized to your special requirements.*



**Draining/Cleaning Basket PP**

- Strong, lightweight rectangular basket
- Suitable for use as a draining basket, autoclave basket or for general storage
- Units stack when not in use to save space
- Excellent chemical resistance
- Autoclavable to 135°

546904

\$99.37 pack of 4

*Azlon*

## Custom Plastic Fabrication

Dynalab Corp's Rochester, New York custom plastic fabrication facility manufactures many products for use in laboratories, industry and education including fume hoods, environmental chambers and laboratory furniture. Plastic fabricators have the capabilities to produce custom jobs following the exact requirements of your application. A few examples of our custom fabrication products include reservoirs, vitrines, tanks, fittings, machine guards, fume hoods, cabinets, chambers, gears, racks and thousands of other industrial and laboratory plastic fabrication items. We have extensive experience in clear acrylic fabrication a common material for custom plastic fabrication projects (especially for Beta Radiation Protection).

Our custom plastic fabrication facilities are capable of producing prototypes as well as high volume job runs. Custom plastic fabrication processes include: Assembly, Bending, Bonding, CNC Lathe Turning, CNC Machining, Cutting, Engraving, Flame Polishing, Forming, Hot Stamping, Inserting, Threading, Ultrasonic Welding and Welding.

We would be happy to provide you with a free quotation and any technical assistance you may require throughout your project. Dynalab works with virtually all types of plastics. We stock a large inventory of sheet, rod, tubing, extrusions, fittings, plastic hardware, perforated sheet, etc. E-mail our custom plastic fabrication department (labinfo@dyna-labware.com) for further information.

# Disposal Box



## Disposal Boxes

- Colorful graphics for quick identification
- Assembly instructions on each box
- Tough 2 mil polyethylene liner
- Folding design for shipping and storage
- Closure assures a safe, hygienic disposal
- Range of convenient sizes

GLASS DISPOSAL BOX	797005	797015	797035
Description	Floor	Bench	Intermediate
Length inches	12	8	12
Width inches	12	8	12
Height inches	27	10	20
Opening diameter inches	7	5	7
Case Quantity	6	6	6
Case Price \$	64.34	43.00	64.34

BURN-UP™ BIN	797025	797045	797065
Description	Floor	Bench	Intermediate
Length inches	12	8	12
Width inches	12	8	12
Height inches	27	10	20
Opening diameter inches	7	5	7
Case Quantity	6	6	6
Case Price \$	64.34	42.17	64.34

There are no replacement bags for Burn-Up™ Bin.  
These boxes should be incinerated after use.

	798015	797055
Printed Description	Plastic Floor model	Non-Hazardous Floor model
Length inches	12	12
Width inches	12	12
Height inches	27	27
Opening diameter inches	7	7
Case Quantity	6	6
Case Price \$	64.34	63.07



## Bio-bin® Waste Disposal Containers

The ideal solution for biohazard or non-hazardous waste  
REDUCE Cost, Weight, Transport, CO2 Emissions, Storage Space

- Space efficient, light weight fold-flat design
- Built-in lid and handles
- Temporary & permanent seals
- Stackable post use. UN 3291 Approved
- Printed user instructions & user ID/date information on lid
- Waterproof construction
- Built-in super absorbent Bio-matt™ to soak up any excess liquid in Bio-bin
- Autoclavable. Use with #202065 Autoclave Sterility Tape.
- Supplied with 2 x 2" Biohazard Waste Labels
- Reorder information printed on the Bio-bin



797303	-0002	-0006	-0030
Description	Loop	Pipette	Floor
Capacity Liters	2.5	6	30
Length inches	9	6	11
Width inches	4.3	6	11
Height inches	4.7	15	16.3
Case Quantity	50	40	10
Case Price \$	151.26	198.71	148.08

797303	-6100	-6200	-6300
Bio-bin Stand	U Stand	Z Stand	M Stand
For use with	-0006	-0006	-0030
Length inches	7	6.7	16.85
Width inches	10.8	6.7	7.12
Height inches	13.3	7.9	11.25
Price Each \$	31.79	31.79	109.29







NEW

**NEW 30 Liter Bio-bin® Spill Containment Trays**

- Ideal spill trays for autoclaving waste disposal containers such as the Dynalon Bio-bins
- Autoclave tray for other plastic or glass laboratory items
- Help contain accidental chemical spills in the laboratory
- Material: Polypropylene (PP)
- 3/16" double-welded construction
- Tested in the USA



797303	-6310	-6320	-6330
Description	Upright	Side Flaps Closed	Side Flaps Open
Volume gallons	2	3	4
Length inches	12	12	12
Width inches	12	18	26
Height inches	3	3	3
Price Each \$	93.83	115.80	145.11

**Droppers, Bellow-Type Bulb, LDPE**



One piece droppers are particularly useful for all applications where the risk of infection or toxicity prohibits mouth pipetting. Graduated to give an indication of the amount of liquid being drawn. Extremely easy-to-use bellows-shaped leakproof bulb provides excellent drop formation.

	262175	262185
Length mm	132.5	194
Stem Diameter mm	7	7
Capacity Draw ml	1.5	5.0
Case Quantity	100	100
Case Price \$	28.61	30.10

**Drying Rack Epoxy Coated** *Azlon*



- High quality draining racks suitable for use with plastic and glass labware
- Made of chemically resistant epoxy coated steel
- There are 8 pegs 110mm long and 24 pegs 80mm in length
- Overall dimensions of the rack are 410 x 300mm
- A free-standing version of the rack is available for bench top use

559165	-0000	-0005
Description	Rack	Rack with integral free-standing support
Price Each \$	75.96	110.54

**Disposal Box - Drying Rack**



**Drying Rack High Impact Polystyrene**

**Kartell**

- Expandable, fasteners to connect additional racks included
- Interchangeable, removable pegs
- NEW Acrylic stand for our most popular drying rack

This 72 place drying rack is molded of high impact polystyrene. It comes supplied with 72 large pegs, draining tubes, fastening stoppers, and expansion hanging hooks which allow coupling with additional racks. The pegs are 4" long and the drip ledge measures 3".



**Drying Rack Stand, Acrylic**

Acrylic stand for our most popular drying rack! This sturdy stand is fabricated of 3/8" clear acrylic adding style and function to a normally wall mounted drying rack 259184-0000 shown above.

The 4.5 lb stand includes all hardware needed to attach to the drying rack. The rack can be tilted up to 20° for added stability and ease of use. Rack can be used vertically or tilted to 20° for added stability.

	259184	259194	159184-0001
Description	Rack	Test Tube Pegs Bag of 11	Stand
Width inches	17	N/A	17
Height inches	24	N/A	21
Price Each \$	268.41	22.44	80.33

## Drying Rack - Eye Wash Station



“MEGA PEG” Drying Boards, 36 Place PP

- Perfect for drying larger labware
- Drip tray with drain tube
- Supplied with 5” removable pegs with longer pegs available



Fabricated of 1/2” polypropylene, these drying racks are perfect for the high volume laboratory. Supplied in two standard sizes but can be fabricated to fit any space requirement. Each board is supplied with the appropriate number of 5” removable pegs with 8” and 12” pegs available as optional accessories. Shelves, holders and bins available on a custom basis. Mounting holes drilled upon request. [Additional sizes available upon request.](#) Please call our customer service department for a free quotation.

	159104	159114	159124 -0001	159124 -0002	159124 -0003
Description	Board	Board	Pegs	Pegs	Pegs
Length inches	72	30	5	8	12
Height inches	36	36	NA	NA	NA
Width* inches	3	3	NA	NA	NA
Price Each \$	670.69	427.53	21.48	23.63	25.78



First EYD Station

**Kartell**

- Emergency eye wash station with integral eye wash bottle

This station is molded of high-impact green polystyrene complete with polyethylene eye wash bottle. The unique bottle is designed to allow quick and immediate flushing to remove foreign matters and help prevent serious eye damage. The head has an air-vent valve to assure air refill of free space in the bottle thus preventing drawback of contaminated wash into the bottle. A perforated spray plate in the eye-cup breaks up the stream to give the eye a gentle wash. A drain tube releases used fluid. Maximum comfort and ease of use. Capacity of bottle is 500 ml (16 oz.).

	205165	206175
Description	Eye Wash Station Complete	Bottle Only 500ml (16 oz.)
Case Quantity	5	5
Case Price \$	256.89	88.10



Evaporating Dishes PTFE

Manufactured from pure PTFE with heavy wall. Supplied in either tall form or low form with pouring spouts. Inert and useable to 260°C. Smooth internal finish.

### LOW FORM

355314	-0025	-0050	-0100	-0180	-0350	-0400
Height mm	10	13	16	19	34	36
Diameter mm	63	79	100	121	130	130
Capacity mL	25	50	100	180	350	400
Price Each \$	17.09	21.35	32.02	39.71	56.77	65.72

### TALL FORM

355304	-0025	-0050	-0100	-0150	-0180	-0250	-0350
Height mm	34	50	50	43	50	50	60
Diameter mm	38	40	64	78	80	97	100
Capacity mL	25	50	100	150	180	250	350
Price Each \$	22.18	27.46	38.98	45.55	53.15	63.83	70.94



**Erlenmeyer Flasks PC with PP Screw Closure, Sterile**

- Made from clear break resistant Lexan® polycarbonate available with or without baffles
- Each flask comes sterile via gamma irradiation, packaged in its own protective bag with dual purpose closure. 0.22 um pore size-for sterile air exchange
- Autoclavable and reusable
- Flasks are certified non pyrogenic & DNase / RNase free for convenience
- These flasks fit all standard shaking incubator clamps and are ideal for culture, media preparation, storage and any related application

**WITHOUT BAFFLES**

641934	-0125F	-0250F	-0500F	-1000F	-2000F
Capacity ml	125	250	500	1000	2000
Neck Size mm	38-430	38-430	38-430	53B	53B
Stopper Size	34/35	34/35	45/50	45/50	45/40
Pack Quantity	24	12	12	6	6
Pack Price \$	219.28	137.45	173.20	155.73	184.57

**WITH BAFFLES**

641934	-0125B	-0250B	-0500B	-1000B	-2000B
Capacity ml	125	250	500	1000	2000
Neck Size mm	38-430	38-430	38-430	53B	53B
Stopper Size	34/35	34/35	45/50	45/50	45/40
Pack Quantity	24	12	12	6	6
Pack Price \$	219.28	137.45	173.20	155.73	184.57



**SEE  
flask drying racks  
on pages 55 - 56**



**Fernbach Flask PC with PP Screw Closure, Sterile**

- Made from clear break resistant Lexan® polycarbonate available with or without baffles
- Sterile and designed for single use, however, can be autoclaved and reused multiple times
- Ideal for all shaker/suspension culture
- Autoclavable and reusable
- Certified pyrogen and nuclease free
- Available with or without baffles

641944	-3000B	-3000F
Description	With Baffle	Without Baffle
Capacity ml	3000	3000
Closure	69B	69B
Neck Diameter mm	67.25	67.25
Width / Diameter mm	230.5	230.5
Height mm	250	250
Height with Cap mm	260	260
Pack Quantity	3	3
Pack Price \$	224.29	224.29
Price Each \$	74.76	74.76



**Erlenmeyer Flasks with Screw Closure PP**

Translucent, wide mouth, flasks with polypropylene screw closures. Printed blue graduations. Excellent chemical resistance. Flasks can also take stoppers. Autoclavable

	341465	341475	341485	341495	341505
Capacity ml	50	100	250	500	1000
Cap Size mm	40	40	52	52	52
Stopper Size	34/35	34/35	45/50	45/50	45/40
Case Quantity	6	6	6	6	4
Case Price \$	45.20	56.53	75.09	89.01	85.38

## Flask



Erlenmeyer Flasks PP

**Kartell**

Molded of chemically resistant, autoclavable polypropylene. Graduations are permanently molded into flask. Autoclavable

	241305	241325	241345	241365	241385	<i>NEW</i> 241405
Capacity ml	50	125	250	500	1000	2000
Graduations ml	10	25	25	50	50	100
Neck NS	14/23	14/23	19/26	24/29	29/32	34/35
Case Quantity	12	12	6	4	2	1
Case Price \$	78.84	85.39	55.81	53.27	36.72	30.47



Volumetric Flasks PP

**Kartell**

Molded to class B tolerance in translucent polypropylene with a tooled neck. Each flask is individually calibrated. Supplied complete with polypropylene stoppers and have the material and temperature characteristics printed in green.

241514	-0025	-0050	-0100	-0250	-0500	-1000
Capacity ml	25	50	100	250	500	1000
Height mm	121	143	174	225	265	325
Base O.D. mm	36	46	58	82	100	120
GL	18	18	18	25	25	25
Case Quantity	5	5	5	5	2	2
Case Price \$	75.08	80.75	95.18	105.47	47.67	60.44



SEE  
connector stoppers  
on page 100



Erlenmeyer Flasks PP

*Azlon*

- Heavy walled, autoclavable, Erlenmeyer flasks with tooled necks
- Supplied complete with polypropylene stoppers
- Temperature characteristics and approximate graduations are clearly and indelibly printed on each flask

541905	-0050	-0250	-0500	-1000
Capacity ml	50	250	500	1000
Cap Size mm	19/26	29/32	34/35	34/35
Base O.D. mm	56	84	107	130
Height* mm	90	140	158	198
Price Each \$	15.30	32.40	36.45	23.21

\* without stopper



Volumetric Flasks with Screw Closure PFA

High transparency, individually calibrated ring markings and supplied with PFA screw closures. Screw closures provide hermetic seal and safety from outside contamination. Withstands high temperatures (270°C) and has outstanding chemical resistance. Leakproof.

	341524	341534	341544	341554	341564
Capacity ml	25	50	100	250	500
Height mm	115	150	180	235	270
Price Each \$	220.00	225.00	329.44	375.25	432.75



**Volumetric Flasks with Screw Closure PMP**

Transparent polymethylpentene (PMP) with class B individually calibrated ring markings. Supplied with polypropylene screw closure. Autoclavable. Maximum use temperature 180° C.

341585	-0025	-0050	-0100	-0250	-0500	-1000
Capacity ml	25	50	100	250	500	1000
Height mm	115	150	180	235	270	310
Base O.D. mm	30	35	40	60	70	85
Screw Cap mm	18	18	18	25	25	32
Case Quantity	6	6	6	5	4	3
Case Price	103.32	122.22	129.87	140.37	130.76	117.51



**Volumetric Flasks with Stoppers, PMP**

These crystal clear volumetric flasks create no meniscus so final readings are easy. Calibrated gravimetrically at 20°C. Thick walls eliminate distortion. Thin necks make final measurement precise. Autoclavable to 170°C. Chemically cleaner than glass and chemically non-absorbant. No wetting. Stopper included. Suitable for foodstuff.

**Kartell**

241574	-0050	-0100	-0250	-0500	-1000
Capacity ml	50	100	250	500	1000
Neck Size	14/23	14/23	19/26	19/26	19/26
Height* mm	143	174	225	265	325
Base O.D. mm	46	58	82	100	120
Case Quantity	5	5	5	2	2
Case Price \$	96.88	114.21	126.53	57.23	72.55

\*with stopper



**Conical Stoppers, PP**

**Kartell**

- Use with plastic or glass erlenmeyer or volumetric flasks

Stoppers manufactured to DIN Standards 12242 ensuring sealing action on nonstandard surfaces.

241415	-0001	-0002	-0003	-0004	-0005
Color	Brown	Yellow	Red	Black	White
Neck Size	14/23	19/26	24/29	29/32	34/35
Lower Ø mm	12,2	16,4	21,1	25,8	30,9
Case Quantity	2	2	2	2	2
Case Price \$	4.43	5.36	7.12	8.09	10.72



**Flask Stand PP**

**Kartell**

This autoclavable ribbed stand supports round bottom flasks that contain up to 10 liters. May be stacked to save space or add height. Dimensions approximately 6 3/4" diameter x 2" high.

240025

\$98.25 case of 5

## Forcep - Funnel



### Forceps - Tweezers PMP

*Azlon*

These strongly readjusting tweezers are available with sharp or rounded ends with fine tooth grips. Supplied in packages of six.

516555	-0001	-0002	-0003	-0004
Color	White	White	Yellow	Yellow
Ends	Sharp	Sharp	Round	Round
Length mm	115	145	180	250
Case Quantity	6	6	6	6
Case Price \$	24.91	33.68	61.44	90.18

### Analytical Funnels PP

**Kartell**

Made of autoclavable polypropylene. These funnels have long, narrow bore that works best for liquids. Maximum temperature for polypropylene is 120°C.

	241605	241625	241645	241665
Top O.D. mm	35	45	65	80
Stem Length mm	37	43	63	68
Stem I.D. mm	3	3	7	8
Case Quantity	100	100	100	100
Case Price \$	218.81	239.83	319.47	442.66

	241685	241705	241725	241745
Top O.D. mm	100	120	150	180
Stem Length mm	80	85	113	140
Stem I.D. mm	8	9	11	11
Case Quantity	50	50	25	25
Case Price \$	296.92	313.24	324.90	377.19



### Forceps - Fine Tweezers, PTFE

They are chemically inert with excellent chemical resistance and virtually non-contaminating. The PTFE resin conforms to FDA requirements for use with Food & Beverage & USP Class VI requirements.

316525	-0100	-0150	-0200
Length mm	100	150	200
Price Each \$	17.44	20.11	28.05

### Forceps - Tweezers PTFE

Totally inert and non-contaminating. Suitable for use up to 260°C.

316504	-0000	-0001	-0002
Description End	Square	Square	Square
Length mm	100	150	200
Price Each \$	43.91	52.67	59.44

316514	-0000	-0001	-0002
Description End	Sharp	Sharp	Sharp
Length mm	100	150	200
Price Each \$	43.91	52.67	59.44

### Mini Funnel PP, 1 Ounce Capacity

Mini-Funnel has numerous lab and industrial applications. Molded of autoclavable polypropylene. Ideal for micro work, filling small containers & bottles, burettes, etc.

412375	
Top I.D. mm	37
Stem Length mm	23
Case Quantity	48
Case Price	56.75

### Lightweight Funnels HDPE/PP

*Azlon*

Economically priced funnels with ribs which prevent air lock and speed filtration. The two smallest sizes are HDPE, the remainder are polypropylene.

542365	-01	-02	-03	-04	-05	-06	-07	-08
Material	HDPE	HDPE	PP	PP	PP	PP	PP	PP
Top I.D. mm	30	30	40	50	75	100	120	150
Stem O.D. mm	2	5	5	9	10	13	14	17
Overall Height mm	45	45	62	78	107	149	170	210
Case Quantity	10	10	10	10	10	10	5	5
Case Price \$	13.59	13.59	16.45	20.27	24.58	43.38	29.96	42.52

542365	-0SET
Set Contains funnels mm	50, 75, 100 & 120 (1 each)
Set Price \$	16.23



## Funnel



PP



HDPE



Long Stem Funnel PP

**Kartell**

### Utility Funnels PP/HDPE

Utility funnels made of polypropylene or high density polyethylene. They are inexpensive, lightweight and designed for general use. The 162mm size (412334-0005) has a very large throat opening.

412334	-0001	-0002	-0003	-0004	-0005	-0006
Material	PP	PP	PP	HDPE	HDPE	HDPE
Holding capacity oz	2	4	8	16	32	64
Top Diameter mm	70	89	108	127	162	203
Height mm	70	102	121	146	178	203
Case Quantity	36	36	24	24	12	12
Case Price \$	57.96	68.98	68.07	98.07	100.85	136.71

212195	-0001
Set Contains funnels oz	4, 8, 16, 32, 64 (1 each)
Set Price \$	31.66



### Funnels HDPE

These funnels are ideal for many applications in the laboratory and industry. Upper portion of funnel is straight sided, helps prevent spill-over. Maximum temperature HDPE is 110°C.

	212105	212115	212125	212135	212145	212155	212165
Inside I.D. mm	100	120	140	180	230	245	290
Stem Length mm	39	48	54	72	84	90	106
Bottom Opening mm	8	9	10	14	17	18	23
Case Quantity	24	24	18	18	12	12	12
Case Price \$	65.28	87.36	88.37	155.27	129.94	188.86	262.86

212195	-0000
Set Contains funnels mm	100, 120, 140, 180, 230 (1 of each)
Set Price \$	31.66

412365  
LDPE



241754	-0001	-0002	-0003
Diameter mm	65	78.5	103.5
Stem Length mm	150	143	145
Stem Diameter mm	8	8	8
Case Quantity	2	2	2
Case Price \$	16.93	19.25	21.35



342345 & 342355  
HDPE

### Large Funnels HDPE/LDPE

Large funnels made of polyethylene. Designed for transferring liquids. 412365-0008 funnel has external ribbing for air release; 412365-0011 has both internal and external ribbing. Maximum temperature for LDPE is 80°C and HDPE is 110°C.

	342345	342355
Material	HDPE	HDPE
Capacity L	6	13
Top O.D. inches	13 1/8	16
Outlet I.D. inches	1.25	1.30
Height inches	11 7/8	14
Stem inches	5	4 7/8
Case Quantity	4	2
Case Price \$	247.08	240.78

412365	-0008	-0011
Material	LDPE	LDPE
Capacity L	4	6
Top O.D. inches	7 5/8	12 1/4
Outlet I.D. inches	0.56	0.63
Height inches	9 1/2	11 1/2
Stem inches	3 5/8	3 1/8
Case Quantity	6	2
Case Price \$	100.21	73.97

## Funnel



### Funnels, PTFE

- Very smooth internal non-stick finish
- Use with liquids or granular solids
- Totally inert and non-contaminating

342325	-0050	-0110	-0220
Diameter mm	30	70	150
Diameter Stem mm	8	12	16
Height mm	50	110	220
Price Each \$	24.04	44.86	171.37



### Powder Funnels PP

These wide stem, autoclavable funnels are translucent and allow for the passage of larger particles. Economical, fast and efficient.

342555	-0065	-0080	-0100	-0120	-0150
Top I.D. mm	65	80	100	120	150
Stem Diameter mm	16	22	23	27	29
Overall Length mm	68	75	94	110	138
Case Quantity	30	30	30	30	20
Case Price \$	118.44	140.40	168.71	202.26	159.87

### Anti-Splash Funnels with Mesh Filter

- Eliminates splashes

Anti-splash ring eliminates spilling of liquids caused by the swirling action created when a liquid is poured into a funnel. Supplied with an attached 100 mesh filter.



	408224	408234	408234-0001
Capacity oz	24	144	Replacement
Top O.D. inches	5.75	9	filters for
Height inches	6.5	10.5	either
Stem Length inches	2.25	3.5	funnel
Spout O.D. inches	0.625	1.125	NA
Price Each \$	9.98	13.50	2.81

### Separatory Funnel Support PP

Polypropylene support for separatory funnels are molded in one piece. Chuck fits rods having diameters from 8mm to 14mm.

264645

\$116.49 pack of 6



### POWDER FUNNEL SET PP

342555	-0SET
Contains funnels mm	65, 100 & 150 (2 each)
Set Price \$	34.83

## Kartell

### Discs for Buchner Funnels HDPE

Made from high density polyethylene, these discs have excellent chemical resistance. They are useful for holding up filter paper. In this way the blocking of the holes is avoided and the filtering surface of the funnel is free. Will withstand temperatures up to 110°C. Mesh size 950 x 700 microns.



242845	-042	-055	-070	-090	-110
Filter Paper Size mm	42.5	55	70	90	110
Case Quantity	50	50	50	50	50
Case Price \$	61.51	66.51	69.21	74.35	79.86

242845	-150	-240
Filter Paper Size mm	160	240
Case Quantity	50	50
Case Price \$	94.91	127.32

### Supports for Buchner Funnels

## Kartell

Set of 7 adapters for Buchner funnels, manufactured of Neoprene rubber.

#### INCLUDES 1 EACH OF BELOW

O.D. mm	Taper Size I.D. mm	Height mm	O.D. mm	Taper Size I.D. mm	Height mm
21 x 11	17 x 7	21	58 x 38	50 x 30	35
27 x 16	22 x 11	22	69 x 45	60 x 36	40
37 x 22	31 x 16	25	86 x 57	75 x 46	45
46 x 29	39 x 22	29			

242864

Price Per Set \$37.84





**Buchner Funnels PP**

**Kartell**

Molded of polypropylene, these funnels are unbreakable and resistant to corrosion and heat, and easily separated for cleaning. Can be used without risk with Erlenmeyer flasks. Optional disks for funnels sold separately. Molded of polypropylene for corrosion resistance, withstands high temperature. No special flask is required.

Light in weight, more stable than glass or porcelain funnels. Can be taken apart for easy cleaning. The smallest size fits bottles with opening from 20 to 57 mm, medium size from 25 to 75 mm, largest size from 30 to 100 mm.

242835	-042	-055	-070	-090	-110
Filter Paper Size mm	42.5	55	70	90	110
Holes mm	1.2	1.1	2	2.5	2.5
Capacity ml	40	70	180	390	810
Case Quantity	12	8	6	4	4
Case Price \$	117.61	106.11	91.14	92.65	137.26

242835	-150	-240
Filter Paper Size mm	160	240
Holes mm	2.75	3
Capacity ml	2,100	6,000
Case Quantity	4	2
Case Price \$	230.95	224.43

### Gamma Protection Information

Gamma (g) rays are produced when an unstable isotope such as 125I enters into nuclear decay. This form of electromagnetic radiation is attenuated by lead. The gamma rays' intensity decreases exponentially as the thickness of the lead increases.

The recommended thickness of lead for use with 125I is 0.5mm, Dynalon uses 3mm lead for all of our g protection products. Other isotopes shielded by our products include 32P, 51CR, 35S, 33P, 3H and 14C. The enclosed boxes are perfect for short term storage of isotopes and contaminated labware. Dynalon gamma disposal boxes feature a polyethylene liner and a sleek black acrylic exterior.

All units come with non-skid feet and are available in additional sizes.

### Funnel - Gamma Protection



**172814-0001**



**172814-0002**

### Gamma and Beta Disposal Bins

3mm thick lead lining serves to attenuate both beta and gamma emitting radionuclides. Radioactive bins feature a polyethylene lining and a sleek black acrylic exterior. Two sizes are available.

Choose either our (172814-0001) 6" L x 10" H x 6" W pipette tip disposal bin or for larger serological pipettes choose from either the 172724 clear acrylic bin for beta emitters or the 3mm thick lead lined bin for gamma emitting radionuclides. Both are 6" L x 16" H x 6" W and will accommodate most glass and plastic pipettes.

All units feature a top hole for either tip ejection or pipette discarding; fully hinged lids for easy removal; and non-skid feet to provide stability. Order polyethylene bags for contamination-free disposal of tips or pipettes. All units come with non-skid feet and are available in additional sizes.

172814-0001	Gamma Pipette Tip Bin, 6" x 6" x 10"	\$485.15 each
172814-0002	Gamma Pipette Bin, 6" x 6" x 16"	\$535.33 each
172724-0000	Beta Pipette Bin, 6" x 6" x 16"	\$207.44 each



Gamma & Beta items on this page are made in our Rochester, NY Fabrication shop and can be made to your project requirements.

### Gamma Desktop Disposal Bin

General Purpose Gamma Desktop Bin. Dynalon gamma disposal boxes feature a polyethylene liner and a sleek black acrylic exterior. Product Dimensions (l x w x h): 6" x 6" x 6". All units come with non-skid feet and are available in additional sizes.

**172814-0003** Gamma Desktop Bin, 6" x 6" x 6" \$407.36 each

## Glass Joint Sleeves - Imhoff Cone



### Reusable PTFE Joint Sleeves

Unique manufacturing process permits superior quality PTFE joint sleeves at unbelievably low prices. Price permits disposability! Elongated cones of micro-thin virgin PTFE film tapered to fit snugly around glass joints. Approximately 0.05 mm (0.002") thick with taper of approximately 1.10 on diameter. Eliminates the need for lubrication and frozen, leaky ground joints. Can be used over a temperature range of -75° to +260° C.

	362595	362605	362615	362625	362635
Standard Taper Size	7/25	10/30	14/35	19/38	24/40
Pack Quantity	6	6	6	6	6
Pack Price \$	32.36	31.19	29.57	30.46	32.83

	362645	362655	362685	362665	362695
Standard Taper Size	29/42	34/45	40/50	45/50	50/50
Pack Quantity	6	6	6	6	6
Pack Price \$	33.63	37.97	43.15	44.79	52.63

	362705	362715
Standard Taper Size	55/50	60/50
Pack Quantity	6	6
Pack Price \$	60.73	72.08



### Hydrometer Jar - Cylinder PP

Translucent polypropylene 500 ml cylinder with overflow cup. Molded graduations. Overall dimensions: 1" I.D. x 12" high (38 x 305mm). Base is 4 1/4" (108 mm) in diameter. Additional sizes upon request.

141805

\$48.24 each

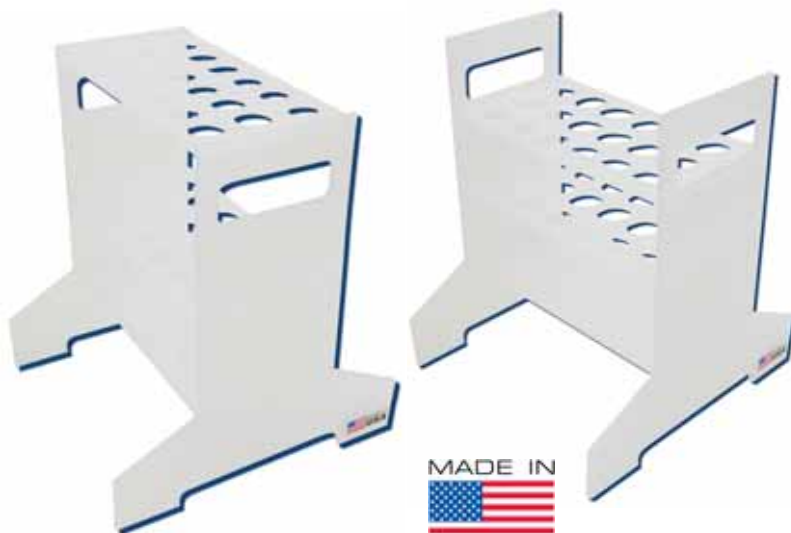

### Hydrometer Racks PP

These 18 place polypropylene racks are specially designed to safeguard glass hydrometers. The three tiered rack with handles allows easy transport and storage of hydrometers. Top two plates have 1" diameter holes while the bottom plate has wells which taper from 1" to 3/8". Additional sizes available upon request.

103215	-0000	-0001
Description	Tall	Short
Plate Height inches	7	5 3/8
Length inches	8 1/4	8 1/4
Width inches	8 1/2	8 1/2
Height inches	9 7/8	9 7/8
Price Each	84.99	84.99



### Imhoff Cone Rack HDPE

Heavy duty welded construction of rigid, high-density polyethylene to support four Imhoff Cones. Cones can be easily read with minimum interference due to design of racks. Dimensions are approximately 15 1/2" x 8" x 14 7/8" high. Additional sizes available upon request.

140344

Imhoff Cone Rack

\$187.69 each

### Imhoff-Type Sedimentation Cone SAN

Unbreakable transparent and molded of styrene-acrylonitrile. Leakproof screw closure at tip for easy withdrawal of sediment and ease in cleaning. Molded graduations in the following divisions up to 1000 ml: 0-2 ml in 1/10 ml, 2-10 ml in 1/2 ml, 10-40 ml in 1 ml, 40-100 ml in 2 ml and 100-1000 ml in 50 ml. Top diameter approximately 4 7/8" x 19 7/8" high.

340295

Imhoff Cone

\$160.09 case of 3



## Innoculating Loop - Label



### Sterile Inoculating Loops and Needles PS

**Kartell**

These inoculating loops have been manufactured by using a special raw material which allows flexibility and high resistance to breakage. In addition, one end of the inoculating loop has been designed to be used as an inoculating needle, giving these loops a double purpose. Sterile, disposable and color-coded.

	226505	226515
Color	Blue	Clear
Capacity µl	10	1
Quantity Per Bag	20	20
Case Quantity	1000	1000
Case Price \$	106.33	106.33



### Close-it and Close-it Food - proven its value repeatedly

- With steam-lock for hermetically sealed closure
- No lumping of hygroscopic powders
- Closure seal that has proven its value repeatedly, even on dusty and slightly moist sacks
- Can be written on using a pen, pencil or felt tip pen
- Samples available

Taking samples from sacks, boxes, Big-Bags, etc. with sampling lances is a common and time-proven practice. This produces holes through which easily flowing bulk goods could escape from the container. Close-it prevents this in an uncomplicated manner.

**Close-it** has been specially developed for this purpose. The label has a sandwich-type structure (aluminum/paper) and seals the container hermetically (vapor barrier). This virtually prevents hygroscopic powders from clumping together. The label is not just used to provide a hermetic seal. It is also used for providing quality control information (sampling date, release yes/no, name of tester, etc.).

The label is available with printing in red and white. "Close-it" can be written on with ball-point pen, pencil or felt-tip marker.

The rear of the label is coated with a powerful adhesive so that "Close-it" sticks firmly to most commercial containers, even to surfaces coated with fine powder where conventional labels or adhesive tape will not adhere. "Close-it", the original, will even stick to slightly moist surfaces. The "Close-it" dispenser ensures safe storage and simple removal of the labels. A built-in marking plate allows the labels to be conveniently written on.

**Close-it food** is for use with foodstuffs. The adhesive on the label complies with European and FDA requirements for direct contact with dry, moist and fatty foodstuffs, European Directives 1935/2004/EU and 2011/10/EU and FDA 176.170 + 175.180 + 178.3620 + 178.3910. Just like the original, "Close-it food" has a barrier layer of aluminum foil.

This means that "Close-it food" is suitable for sampling foodstuffs, pharmaceuticals, cosmetics, food additives – in short, for all applications in which the product must not be contaminated by contact with the adhesive.

Supplied in the proven size of 95 x 95 mm in rolls each with 500 control seals or in 150 x 150 mm in rolls of 250 seals.



### CLOSE-IT

853033	-0002	-0012	-1012	-1002
Color	white	red	red	white
Description	unprinted	printed	printed	unprinted
Size mm	95x95	95x95	150x150	150x150
Labels per roll	500	500	250	250
Price per roll US\$	119.73	119.73	167.79	167.79

### CLOSE-IT FOOD

853033	-2017	-2018	-3017	-3018
Color	Red	White	Red	White
Description	printed	unprinted	printed	unprinted
Size mm	95x95	95x95	150x150	150x150
Labels per roll	500	500	250	250
Price per roll US\$	119.73	119.73	167.79	167.79

### ACCESSORIES

853033	-9000	-9100
Description	Dispenser for labels 95 x 95 mm	Dispenser for labels 150 x 150 mm
Price each US\$	142.97	200.52

## Label & Seals



### Close-it Tape - for holes and tears in bags or sack like packaging

Available in rolls of 50 meters. Use "Standard" product for non food items such as chemical bags and use "Food" tape for food item packaging. The "Food" tape has an adhesive that is food compatible. Use on paper, burlap and other typically adhesive repellent surfaces.

Close-it Tape has an extremely strong adhesive strength and will stick to many diverse substrates. White in color with gridded dots for cutting, it can be labeled with permanent ink.

Use a small piece for closing a small hole or for marking a specific point. Or repair a large hole or a long tear quickly, reliably and easily. Supplied in the proven size of 95 x 95 mm in rolls each with 500 control seals or in 150 x 150 mm in rolls of 250 seals.

853033	-0017	-1017	-2019	-3019
Description	Standard	Standard	Food	Food
Width mm x Length Meter	95x50	150x50	95x50	150x50
Price per Roll \$	119.73	167.79	119.73	162.79



### SampleSafe Seal PP - secures bottles and jars with eyelets

These seals are made of stable polypropylene and consist of a 270mm seal ring and a tab. The tab is uniquely identified with a serial 9 digit number. The seal ring diameter is 2mm, thin enough to fit through small eyelets and slits. The seal tab is secured by inserting the seal ring through the container eyelet and then through a one-way hole in the tab until it is pulled tight. The container is now Tamper evident. 2mm Diameter

853994-2902      SampleSafe Seal PP Red      \$172.73 Pack of 100



### Seal-it Security Seal - to seal retention sample containers and to tamper-proof packaging

Use Seal-it Security Seals with a unique identification number to tamper proof containers such as bottles, sample bags, sacks, specimen bags, envelopes etc. The powerful adhesive sticks to all conventional containers and the inherent aluminum foil adapts to any container shape. If manipulated, the cross perforations tear. Seal-it cannot be removed without being torn or destroyed, providing tamper evident proof! Product has a white labeling area for marking with all conventional writing tools: e.g. list contents, sampling date, names etc. An integrated control label with the same ID number can be applied to accompanying documents. Dimensions: 178mm x 30mm (l x w)

853994-0003      Seal-it Security Seals, Red      \$236.72 Roll of 500

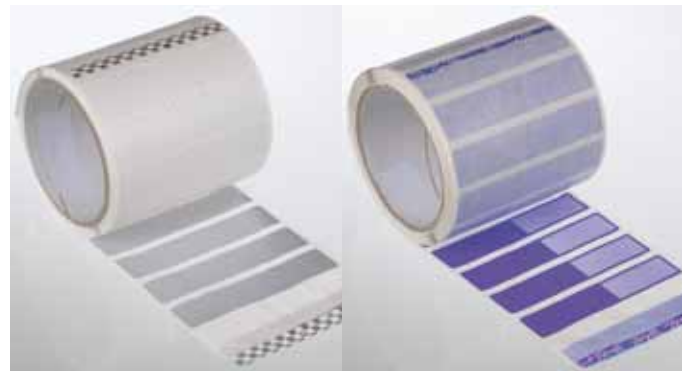

### Tamper Proof Labels

**Safe-it** and **Secure-it** can be used as tamper evident security labels designed for sealing containers as well as letters, parcels etc. They provide a visual indicator of any tampering of critical samples. If removed, the label divides into separate layers. A hidden pattern then appears on the surface which is permanent. The glue also leaves a residue on the surface that cannot be removed. Dimensions: 95mm x 20mm (l x w).

**Safe-it** Tamper Proof Labels (left in above images): Breaking the security seal reveals visible proof of tampering. A silver checkerboard pattern appears on both the subsurface and surface of the sticker.

**Secure-it** Tamper Proof Labels (right in above images): Secure-it is similar to Safe-it but has a marking area for notes and comments. Like Safe-it, breaking the security seal of a Secure-it label reveals visible proof of tampering. A bright purple stop sign pattern appears on both the subsurface and surface of the label.

853033-5000      Safe-it Tamper Proof Labels      \$162.97 Roll of 500  
853033-5010      Secure-it Tamper Proof Labels      \$245.56 Roll of 500



**BenchGuard™**  
"Totally Absorbing"

BenchGuard and BenchGuard Extra have highly absorbent upper surfaces that contain spills and a tough polycoated base to protect your work surface. Standard BenchGuard absorbs up to 400ml per square meter. For your most demanding applications choose BenchGuard Extra - it absorbs up to 800ml per square meter. BenchGuard and BenchGuard Extra are available in either pre-cut sheets or a roll dispenser that has a built in cutting edge for easy cutting of any size sheet.

504314	-0001	-0002
Description	Regular roll	Extra absorbent roll
Length meters	50	50
Width cm	49	49
Price Each \$	163.65	216.20

504314	-0003	-0004
Description	Regular Wallet	Extra absorbent wallet
Length cm	60	60
Width cm	49	49
Case Qty sheets	50	50
Case Price \$	188.09	107.49



**Ribbed Matting**

- For lining shelves, drawers or use as a floor liner
- 5 times as thick as normal shelf/drawer liner
- Ribs hold dirt and spills

Clear polyethylene ribbed matting. Perfect floor liner goes down quickly and lies flat. Ribs hold dirt until it can be wiped away. As a shelf and drawer liner, heavy weight matting is five (5) times as thick as normal shelf liner. Easily cut with regular scissors but it won't tear! Also useful under drums or carboys. Heavy weight matting .036" thick with ribs.

404225	-0001	-0003	-0004
Width inches	30	30	30
Length feet	50	15	100
Case Quantity feet	50	15	100
Case Price \$	105.39	31.61	169.02



**Slip-Stop Matting - reusable and washable**

- Put an end to slips and messy mishaps anywhere
- Tacky mats hold objects firmly in place
- Contribute to safety by reducing glass breakage
- Use with shakers and stirrers to hold flasks
- Additional sizes available upon request

	404154-0000
Width inches	16
Length inches	6
Thickness inches	1/32
Price Each \$	9.09

**Custom Plastic Fabrication**

Dynalab Corp's Rochester, New York custom plastic fabrication facility manufactures many products for use in laboratories, industry and education including fume hoods, environmental chambers and laboratory furniture. Plastic fabricators have the capabilities to produce custom jobs following the exact requirements of your application. A few examples of our custom fabrication products include reservoirs, vitrines, tanks, fittings, machine guards, fume hoods, cabinets, chambers, gears, racks and thousands of other industrial and laboratory plastic fabrication items. We have extensive experience in clear acrylic fabrication a common material for custom plastic fabrication projects (especially for Beta Radiation Protection).

Our custom plastic fabrication facilities are capable of producing prototypes as well as high volume job runs. Custom plastic fabrication processes include: Assembly, Bending, Bonding, CNC Lathe Turning, CNC Machining, Cutting, Engraving, Flame Polishing, Forming, Hot Stamping, Inserting, Threading, Ultrasonic Welding and Welding.

We would be happy to provide you with a free quotation and any technical assistance you may require throughout your project. Dynalab works with virtually all types of plastics. We stock a large inventory of sheet, rod, tubing, extrusions, fittings, plastic hardware, perforated sheet, etc. E-mail our custom plastic fabrication department (labinfo@dyna-labware.com) for further information.

# Melting Point - Paddle



## NEW Design

### Digital Melting Point Device

- Space saving compact design.
- Digital LED temperature display with 0.1°C resolution.
- 3 indicator lights (Heating, Fast, Slow) advising the procedure in process.
- Heating block with plastic cover to protect the user; cover is easily removed for cleaning.
- Magnifying lens that allows a view of up to two samples illuminated clearly by a built in LED light.
- Adjustable Slow Speed temperature ramp rate from 1°C to 10°C.
- Fast Stage temperature set that saves time prior to carrying out the melt procedure.
- Metal feet that extend and help provide an appropriate viewing angle.
- "Read" button that captures the melt temperature allowing for an accurate recording
- Self calibration screw

The Dynalon DMP100 Melting Point Device is a convenient, safe, fast and easy to use digital product that determines the melting point of a substance without the need for a mercury thermometer. The DMP100 makes measurement simple and is ideal for use in educational chemistry labs. It can be an indispensable bench top tool for the modern science education laboratory and for select industrial application areas such as quality control testing for the purity of pharmaceutical and other organic crystalline solids. Priced economically with a 3 year warranty.

The DMP100 includes an Operations Manual with detailed use instructions and one pack of 100 glass capillary tubes, open on one end.

Dimensions: . . . . . 8.7 x 6.3 x 6.7" (l x w x h)  
 Weight . . . . . 4lb  
 Electrical Supply . . . . . 120V, 60Hz  
 Temperature Range . . . . . Ambient Temperature to 300°C  
 Accuracy of . . . . . +/- 1°C at 20°C; +/- 2.5°C at 300°C  
 Digital Display/Resolution . . . . . 4 Digit LED/0.1°C  
 Temperature Ramp Rates  
 Fast Temp Rate . . . . . 20°C  
 Slow Temp Rate . . . . . Between 1°C and 10°C  
 LED Indicator Lights



DMP100	Melting point device, with pk/100 melting tubes, closed one end.	\$999.00 each
DMP100/10	Glass melting tubes, sealed one end	\$10.48 pack 100
SMP1/4	Glass melting point tubes, open ends	\$39.59 pack 100
SMP2/1	Glass melting point tubes, sealed ends	\$62.42 pack 100

### Instrument Dust Cover, Acrylic

- Transparent acrylic
- Power cord opening

Made of transparent acrylic with an opening for the power cord(s), the Instrument Dust Cover offers an inexpensive way to help protect instruments. Small handle on top allows for easy removal. Additional sizes available upon request.

171004 Instrument Dust Cover 15 x 12 x 8" \$72.22 each



### Paddles, Stirring HDPE

High density polyethylene paddle and handle. Small size paddle is for use in stirring small volumes or for chemical mixing in photographic work. The larger size paddles are excellent for mixing liquids in large tanks or vats. Additional sizes available upon request.

	107165	107185	107195	107215
Description	Small	3 Foot	6 Foot	Small
Paddle dimensions inches	2 x 3	3 x 6	3 x 6	2 x 3
Paddle description	solid	solid	solid	perforated
Handle diameter inches	1/2	1	1	1/2
Handle length inches	20	36	72	20
Pack Quantity	4	4	1	4
Pack Price \$	82.77	173.72	58.25	95.28



### Paddles, Scraping Nylon®

Nylon® paddle scraper with plastic handle that will not scratch glass.

	490844	490874
Blade Description	Firm	Soft
Paddle dimensions inches	4 1/2 x 7	4 1/2 x 7
Handle length inches	40	40
Price Each \$	72.72	65.16



**Heavy Duty Pail HDPE**

Fabricated entirely from high density polyethylene, this 4 gallon pail is suitable for use with most acids and other corrosive liquids. The pail has a large spout and strong handle. Graduation marks are attached to the outside of pail in approximately one gallon and liter increments. Dimensions: 11"H x 14" Top Ø x 10.5" Bottom Ø. Wall thickness .090"

113074

\$200.40 each



**NEW**

**NEW Bucket with Graduations and Spout, LDPE**

These LDPE buckets with easy pour spout are graduated internally in liters (TC-to contain). The steel bale handle has a comfortable grip. Suitable for food and beverage products with good to excellent chemical resistance especially at room temperature. Use up to 80°C or well below freezing.

	-0009	-0012	-0017
Capacity liters	9	12	17
Capacity gallons	2.37	3.17	4.49
O.D. inches	9.84	11.02	12.2
Height inches	11.02	11.81	13.38
Price Each \$	16.75	22.15	32.35



**5 Gallon Pail HDPE**

This pail features double wall and horizontal ribs on edging for diametrical strength. The sturdy bail handle made of galvanized steel. Tapered body allows nesting for a 75% space-saving in storage and shipping. May be ordered with or without tight fitting cover.

	413124	413144
Description	Without cover	With cover
Bottom O.D. inches	13.2	13.2
Height inches	14.4	14.4
Pack Quantity	4	4
Pack Price \$	92.69	101.35



**Stirring Kit, HDPE**

- FDA Compliant HDPE
- Purchase individual components or as an entire kit
- Stirrer kit includes 3 convenient handle lengths and two paddle heads

Dynalon's new versatile modular liquid handling series fits all your needs. Interchangeable threaded components make using this product line quick, fun and easy!

Catalog Number	Description	UOM	Price
107035-2000	Stirrer Kit (1 each below)		\$174.25
107035-0001	1.5' Handle	EA	35.89
107035-0002	3' Handle	EA	43.72
107035-0003	6' Handle	EA	55.27
107035-0007	Stirring Paddle	EA	23.55
107035-0008	Perforated Mixing Paddle	EA	35.18



**Pails PP**

Unique natural polypropylene buckets. Able to withstand a large range of corrosives. Graduated in one liter increments. Autoclavable.

	-0012	-0015
Capacity liters	12	15
Capacity gallons	3	3.42
Top O.D. inches	12.16	12.16
Bottom O.D. inches	7.25	8
Height inches	12	13.6
Pack Quantity	4	4
Pack Price \$	289.92	287.64

## Pails - Petri



413504

### Screw Top Pails HDPE

Features tough construction that won't buckle even when stacked. Meets EPA regulations. Lid locks and relocks. Designed for dry or liquid contents.

	413504	413514	413534	413544	413554
Capacity gallons	1.2	2.5	3.5	5	6
Top I.D. inches	7.5	9.02	11.25	11.25	11.25
Bottom I.D. inches	6.63	8.26	10.26	10.26	10.26
Height inches	7.94	9.10	10.87	14.53	17.00
Pack Quantity	6	6	6	4	4
Pack Price \$	100.24	149.81	179.82	133.37	141.16



413554



413015

### Pails with Cover HDPE

- Tight fitting snap-on covers
- Suitable for use with food

Heavy-duty pails, molded of high density polyethylene. Rigid construction. Steel bail handle with plastic hand grip. Snap-on cover is included.

	413015	413035	413045	413065
Capacity quarts	4	8	12	16
Capacity gallons	1	2	3	4
Top O.D. mm	211	246	266	273
Height mm	186	236	254	329
Pack Quantity	6	6	6	6
Pack Price \$	73.35	94.33	106.43	166.50



413045



### Petri Dishes - now available in sleeves of 20 each!



All Sterilin petri dishes are manufactured under strict aseptic conditions within a Class J clean room which complies with BS 5295.

Petri dishes remain under clean room conditions throughout the manufacturing process. An in-house microbiology laboratory performs all the necessary testing, including that of sterility.

Sturdy polyethylene sleeves which exceed BS611 Part II are used to pack all Petri dishes. An inner liner compartments the carton and ensures that Petri dishes arrive in perfect condition. All cardboard used is of recycled grade.

502014	-07	-07P
Size mm (nominal)	50	50
Color	Clear	Clear
Vents	Single	Single
Base Diameter mm	49.98	49.98
Height mm	20.3	20.3
Quantity	500/CS	20/PK
Case Price \$	439.48	18.46

## NEW

### NEW Petri Dishes



- Transparent Polystyrene and optically clear
- Stackable
- For single use
- Sterile by irradiation  
(-0000 is gamma irradiated; -0004 is E-Beam irradiated)
- Consistent flatness allows for even media distribution
- Certificate of Sterilization upon request
- Traceable by batch number

402024	-0000	-0004
Size mm (nominal)	100	100
Color	Clear	Clear
Vents	None	Four
Dishes per Sleeve	20	25
Quantity per Box	480	500
Case Price	\$121.44	\$126.48



### Petri Dish Stand, Epoxy Coated



These useful stands will hold up to six 100mm petri dishes. Manufactured from epoxy coated steel they are fully autoclavable and ideal for small batch incubation.

503175-0001

\$83.33 pack of 4

### Parafilm® Dispenser/Cutter

Acrylic dispenser provides dust-free storage and serrated cutting surface for easy dispensing of 4" Parafilm® rolls. The smoke colored acrylic helps prevent film from yellowing over time and is easy to clean.



	176205	176215
Description	Clear Acrylic	Smoke Acrylic
Length inches	6 3/8	6 3/8
Width inches	5 1/8	5 1/8
Height inches	5 3/4	5 3/4
Price Each \$	157.09	157.09







**Disposable Pipettes PS - now available in packs!**



- Sterility guaranteed by gamma irradiation
- Excellent accuracy, better than  $\pm 1\%$
- Crystal grade polystyrene for improved clarity
- Easy-open color-coded tear strips
- Ascending and descending graduations for accurate pipetting
- Drawn tips allow every drop to drain freely
- Special products manufactured to customer specifications

Crystal grade polystyrene is used for consistency in manufacture and maximum clarity, with easy to read crisp black printed graduations enabling the pipettes to be used accurately to  $\pm 1\%$ . Sterility is guaranteed by gamma radiation at a license holding irradiation plant, which follows the relevant recommendations in the DHSS Guide to Good Manufacturing Practice for Sterile Medical Devices and Surgical Products. Sterilin pipettes are tested for pyrogencity, and have a pyrogen level of less than 0.25 EU/ml. All listed pipettes are individually wrapped.

502754	-01	-02	-03	-05	-18
Size ml	1	2	5	25	10
Suction Adapter	No	No	Yes	Yes	Yes
Overall Length mm	279	279	298	348	333
Packaging	Single	Single	Single	Single	Single
Graduations ml	0.01	0.01	0.1	0.2	0.1
Type	Standard	Standard	Standard	Standard	Standard
Adapter Diam. mm	4.8	5.0	6.45	8.0	7.40
<b>Pack Quantity</b>	<b>100</b>	<b>100</b>	<b>50</b>	<b>25</b>	<b>50</b>
<b>Pack Price \$</b>	<b>25.90</b>	<b>26.25</b>	<b>21.04</b>	<b>30.88</b>	<b>21.91</b>
Case Quantity	1000	1000	200	200	500
Case Price \$	207.10	209.89	67.32	197.79	175.31



**MiniFIX Micropipettes**

**Kartell**

- Good for ~5,000 pipettings
- Fixed volume from 5uL to 1000uL
- Cost effective, Autoclavable
- Ideal in schools for routine applications where speed and precision is required
- Color-coded button for easy volume identification
- Accommodates all common tips

This line of fixed volume mini-micropipettes consists of ten pipettes covering the range from 5 uL to 1000 uL. These pipettes feature a compact design, with a length of approximately 13cm, and weight of less than 10g. They are single blister packed, with calibration and performance certification. Each MiniFIX is marked with its volume, and the push button is color coded for easy "volume" identification.

240234	-0005	-0010	-0020	-0025	-0050
Volume uL	5	10	20	25	50
Accuracy %	$\pm 1.5$	$\pm 1.0$	$\pm 0.5$	$\pm 0.5$	$\pm 0.4$
C.V. %	$\pm 1.0$	$\pm 1.0$	$\pm 0.5$	$\pm 0.5$	$\pm 0.3$
Price Each \$	23.41	23.41	23.41	23.41	23.41

240234	-0100	-0200	-0250	-0500	-1000
Volume uL	100	200	250	500	1000
Accuracy %	$\pm 0.3$	$\pm 0.3$	$\pm 0.3$	$\pm 0.3$	$\pm 0.3$
C.V. %	$\pm 0.3$	$\pm 0.2$	$\pm 0.2$	$\pm 0.2$	$\pm 0.2$
Price Each \$	23.41	23.41	23.41	23.41	23.41



**MiniFIX Rack**

Made of transparent acrylic, the MiniFIX Microliter Pipette Rack will hold up to 5 microliter pipettes. Helps to organize your lab and keep the pipettes at your finger tips. Product dimensions: 7" L x 6" W x 7" H O.D. *Additional sizes available upon request.*

140234



\$32.51 each



**302765 Graduated**



**303005 Volumetric**

**Graduated Measuring and Volumetric Pipettes PP**

Translucent polypropylene. Resistant to breakage. Blue graduations, ring mark and inscriptions. Ideal for fluoro and silicate chemistry. Recommended cleaning with mild alkaline detergent up to 60°C. Note: Exposure to temperatures above 60°C may cause volume changes.

**GRADUATED PIPETTES PP**

302765	-0001	-0002	-0005	-0010
Capacity ml	1	2	5	10
Error Limit +/- mL	.02	.02	.03	.04
Sub Divisions ml	0.1	0.1	0.5	0.1
Case Quantity	12	12	12	12
Case Price \$	148.72	163.67	174.37	180.73

**VOLUMETRIC PIPETTES PP**

303005	-0001	-0002	-0005	-0010	-0025	-0050
Capacity ml	1	2	5	10	25	50
Error Limit +/- mL	.02	.02	.03	.04	.06	.1
Case Quantity	12	12	6	6	6	6
Case Price \$	155.30	159.50	148.85	185.03	191.38	339.37

## Pipette - Pipette Accessories



NEW

### Pipette Storage Sterilizing Box PP

Azlon

This unique round box is autoclavable at 121°C. The patented thread closure enables the box length to be changed from 280mm (11") to 500mm (20") and also makes it suitable to different length pipettes. Diameter 65mm (2 1/2").

511224

\$91.81 pack of 5



### NEW Wide Orifice Graduated Pipette

- Sampling small volumes of viscous substances
- 10mL capacity with 0.1mL sub divisions

Translucent polypropylene. Resistant to breakage. Blue graduations, ring mark and inscriptions. Use with pipettor. Recommended cleaning with mild alkaline detergent up to 60°C. Note: Exposure to temperatures above 60°C may cause volume changes. **Additional sizes available upon request.**

102774-0010

\$15.06 each



### Pipette Rack PP

Azlon

A white molded rack which will support 12 straight or small bulb pipettes over 200mm long. It is a very stable rack supplied as a kit of two end pieces and three connecting rods for push-fit assembly in seconds and can be easily dismantled for storage when not needed.

511235

\$24.31 each



### Pipette Rack Acrylic

Clear acrylic pipette rack permits easy storage and access to pipettes. The four shelves have an upward angle for secure storage and easy access. Measures 3 3/8"W x 12 1/4"D x 13"H O.D. **Additional sizes available upon request.**

186665

\$139.17 each



### Workstation Storage/Dispenser Bins

Fabricated from white and clear acrylic. These storage/dispenser bins are available in four sizes and ideal for holding and dispensing many small items used in the laboratory. The hinged top cover assures easy filling and the up front hinged cover provides a generous opening for easy removal. All items stored remain dust-free, yet visible through the clear acrylic front window. **Additional sizes available upon request.**

	106245	106255	106265	106275
Holds/dispenses	Pasteur Pipettes	Pasteur Pipettes	12x75mm tubes	16x100mm tubes
Length inches	6	6	8	8 1/2
Width inches	6 1/2	6 1/2	3 1/2	5 1/2
Height inches	14	7	12	16
Price Each \$	135.16	103.23	141.77	130.00



### Gamma and Beta Pipette Disposal Bins

3mm thick lead lining serves to attenuate both beta and gamma emitting radionuclides. Radioactive bins feature a polyethylene lining and a sleek black acrylic exterior.



Choose either the 172724 acrylic bin for beta emitters or the 3mm thick lead lined bin for gamma emitting radionuclides. Both are 6" L x 16" H x 6" W and will accommodate most glass and plastic pipettes.

All units feature a top hole for either tip ejection or pipette discarding; fully hinged lids for easy removal; and non-skid feet to provide stability. Order polyethylene bags for contamination-free disposal of tips or pipettes. [Additional sizes available upon request.](#)

172814-0002	Gamma Pipette Disposal Bin	\$535.33 each
172724-0000	Beta Pipette Disposal Bin	\$207.44 each

**SEE additional Gamma products on page 63**



### Disposable Micropipette Tips, Economy

Universal yellow and blue tips are designed to fit a wide range of micropipettes, Eppendorf Type such as Brand, Gilson, Finn pipette and Socorex - Graduated. \*Approximately 4% of Blue tips have reference marks for positive quality control.

	262205	262215	262245	262265	262275
Capacity µl	1-200	101-1000	5-200	5-200	201-1000
Color	Yellow	Blue	Neutral	Neutral	Neutral
Description	Universal	Universal	Oxford Slim	MLA	MLA
Case Quantity	1000	1000	1000	1000	1000
Case Price \$	32.60	28.48	33.49	30.07	48.89

## Pipette Accessories - Pipette Tip



### Automatic Pipette Washing Set



Solve the problem of washing pipettes speedily, safely and with little effort. Dirty pipettes soak in the pipette basket in the pipette jar and the basket is transferred to the washer where a constant flow of tap water rinses the pipettes clean.

	215905	215915	215925	215905-0001
Description	Washer	Jar	Basket	Complete Set
Height inches	25.5	25.5	26	25.5
Diameter inches	6.5	6.5	5	6.5
Price Each \$	281.61	130.60	86.35	482.73



### Premium Quality Pipette Tips

- Accurate dimensioning and tight fit
- Clean, accurately centered tip orifice
- Excellent surface properties - smooth and free from edges
- Very good translucence

	373205	373215
Capacity µl	2 - 200	101 - 1000
Description	Yellow tips	Blue tips
Bulk Packed Quantity	1000	1000
Pack Price \$	27.36	30.35



### Pipette Tip Disposal Bin (Gamma Protection)



3mm thick lead lining serves to attenuate both beta and gamma emitting radionuclides. Radioactive bins feature a polyethylene lining and a sleek black acrylic exterior. All units feature a top hole for either tip ejection or pipette discarding; fully hinged lids for easy removal; and non-skid feet to provide stability. Order polyethylene bags for contamination-free disposal of tips or pipettes. [Additional sizes available upon request.](#)

172814-0001	\$485.15 each
-------------	---------------

## Pipettor Accessories



### Pipettor Holder

Made from clear acrylic or high density polyethylene. This pipettor holder accommodates most major brands of pipettors making it a useful addition to any laboratory. The pipettor holder comes in three standard sizes for 3, 4 or 6 pipettors. The upper rack has 26.1mm (1.02") slots. The lower rack has 16mm (.625") slots. The new black HDPE U.V. stabilized 6 place pipettor holder (186694) is chemically resistant and easy to clean. Perfect for use in DNA workstations and other areas where U.V. anti-germicidal lamps are used. All pipettor holders are supplied with non-skid feet. [Additional sizes available upon request.](#)



	186614	186624	186634	186644	186674	186694
Description	4 place	6 place	4 place	6 place	3 place	6 place
Material	Acrylic	Acrylic	HDPE	HDPE	Acrylic	Black HDPE
Height inches	12	12	12	12	12	12
Depth inches	8	8	8	8	8	8
Width inches	8	12	8	12	6	12
Price Each \$	58.19	64.23	51.93	61.80	61.62	83.40



### Pipettor Stand Workstation

Keep pipettors and disposable tips handy at all times in one convenient stand. A self-closing lid provides dust free storage for a generous supply of two sizes of pipette tips. The built-in rack stores up to six pipettors. The bottom, sides, and top pipettor rack are white acrylic; the bins have a transparent front and cover for easy identification of their contents.



Overall dimensions: 9 1/2" H x 16 3/8" W x 6 5/8" deep. Two bin dimensions: 5" H x 8" W x 3" deep. Holes at top are 17/32" diameter. [Additional sizes available upon request.](#)

162385

\$167.73 each

**SEE  
pipettes on page 71**



### Pipette Filler Holder

Made from clear acrylic. The pipette filler holder fits most pipette fillers. Holder dimensions are 9"H x 6"D x 5 1/2"W. The hole is 1.25". [Additional sizes are available upon request.](#)

186655

\$105.90 each



### Multi-Channel Pipettor Stand

Made from clear acrylic, this one piece multi-channel pipettor stand accommodates most of the major brands of multi-channel pipettors. [Additional sizes are available upon request.](#)

186684

\$62.04 each



### Levo Pipette Controllers

- Comfortable – simple to use
- Precise pipetting – use with glass or plastic volumetric and graduated pipettes from 0.1 to 100mL
- Blow out feature
- Uses protective/replaceable syringe filter - easy access
- 4 colors available for quick identification.

411125	-0001	-0002	-0003	-0004	722912
Color	Blue	Green Y	ellow	Pink	Filter
Length inches	8	8	8	8	Inline PTFE
Width inches	2	2	2	2	3 micron
Price Each \$	53.15	53.15	53.15	53.15	5.26

## Pipettor Controller



### Pipettor Filler with Plunger

**Kartell**

Simply press plunger to fill pipette, release thumb to retract. Knurled cap adjusts the plunger stroke for repeating preset volume. Rubber chuck will hold pipette securely and safely. Comfortable grip. For use with 10ml pipettes, lower capacities can easily be over filled. Provided with graduations on the body molded in yellow ABS.

237825

\$355.39 case of 6



### Pipettor Vadosa

**Kartell**

Safety vacuum pipetting device, easy to use, able to draw up and measure any liquid, even the most viscous one. Vadosa fits every type and size of pipette from 0.1ml up to 25ml. Will deliver even the smallest quantities with simplicity, precision and speed. Just insert a pipette into the Vadosa vacuum pipetting device, tighten the chuck, immerse the pipette in liquid, then rotate the micrometer type tap until you draw up the desired quantity of liquid. Made of acid and alkali-resistant polypropylene.

210995

\$235.15 case of 4

## Custom Plastic Fabrication

Dynalab Corp's Rochester, New York custom plastic fabrication facility manufactures many products for use in laboratories, industry and education including fume hoods, environmental chambers and laboratory furniture. Plastic fabricators have the capabilities to produce custom jobs following the exact requirements of your application. A few examples of our custom fabrication products include reservoirs, vitrines, tanks, fittings, machine guards, fume hoods, cabinets, chambers, gears, racks and thousands of other industrial and laboratory plastic fabrication items. We have extensive experience in clear acrylic fabrication a common material for custom plastic fabrication projects (especially for Beta Radiation Protection).

Our custom plastic fabrication facilities are capable of producing prototypes as well as high volume job runs. Custom plastic fabrication processes include: Assembly, Bending, Bonding, CNC Lathe Turning, CNC Machining, Cutting, Engraving, Flame Polishing, Forming, Hot Stamping, Inserting, Threading, Ultrasonic Welding and Welding.

We would be happy to provide you with a free quotation and any technical assistance you may require throughout your project. Dynalab works with virtually all types of plastics. We stock a large inventory of sheet, rod, tubing, extrusions, fittings, plastic hardware, perforated sheet, etc. E-mail our custom plastic fabrication department (labinfo@dyna-labware.com) for further information.



**Kartell**

### pi-pump® Fast Release

Many years of trouble-free use have made the pi-pump® one of the world's most popular pipetting aids. Accurate, precise and safe—even for use with toxic or corrosive chemicals. Simply rotate the wheel forward or backward for easy and precise filling or emptying. Color-coded by size for easy identification. When the wheel is stopped, the piston remains in the required position and holds the liquid inside until ejected. pi-pump® provides a firm, positive fit for all standard pipettes.

	311065	311085	311105
Color	Blue	Green	Red
For Pipettes Up To ml	2	10	25
Pack Quantity	12	12	12
Pack Price \$	295.18	298.11	356.75

NEW



**NEW Mini Solvent Pump**

*Reliable filling of small quantities*

The Mini Solvent Pump is a high-quality hand pump for use with liquids and flammable media such as acetone, ethanol, isopropanol and methanol. Use with small containers such as bottles, canisters, carboys and tanks with GL45 threads, from 1 liter up to ~ 10 liters in size.

Accessory thread adapters are available that allow this pump to fit on S40, GL38 & GL32 threads.



The pump works according to the excess pressure principle. Through use of the pump ball and the PTFE tubing, liquid is forced from the container due to the pressure build up. The pump includes a pressure relief valve for safety purposes.

Parts that come into contact with the media are stainless steel (1.4301 and 1.4404) and PTFE tubing cut to size; both have excellent chemical resistance. Also included is a grounding cable that easily inserts into the pump housing, for the purpose of diverting any electrostatic charges.

The Mini Solvent Pump is compact and very well balanced. Dosing of liquids occurs through the valve with an auto-stop function. It is very precise with no dripping even into small containers such as test tubes. Tubing can be attached to the discharge spout to fill containers at a further distance. The high quality materials ensure neat and reliable filling throughout a very long service life.

Mini Solvent Pump includes:

- PTFE tubing 0.4 meters
- Grounding cable, 2 meters
- Mini Solvent Pump SS/PTFE GL45

**856033-4000**

**Mini Solvent Pump**

**\$631.18 each**

Accessories:

#0006-4000	Thread Adapter PTFE GL45-S40	\$53.58
#0006-4002	Thread Adapter ETFE GL45-GL38	\$53.58
#0006-4003	Thread Adapter ETFE GL45-GL32	\$53.58
#0006-9506	Tubing Cutter	\$14.83
#8804-0608	PTFE Tubing, 6 x 8mm, 5 m Roll	\$79.95



**Pump, Water Jet Vacuum**

The ideal instrument for generating vacuum and extracting liquids and vapors. The flow configuration has been optimized resulting in a reduction of water consumption to one third of customary values (190 Liters per hour at 3.5 bar water supply pressure). The maximum pressure of 16 m bar is reached across a wide range of water supply pressures (from 3 to 6 bar). The suction capacity is approximately 400 Liters per hour of air (against atmospheric pressure at a water supply pressure of 3.5 bar at 12°C).

312635

\$41.00 each



**Burette Rack, Wall Mounted, PP**

- Safely organizes up to 10 glass or plastic burettes depending on length
- Additional sizes available upon request.

	185514-4490
Depth inches	3
Width inches	18.5
Height inches	20.25
Weight lbs	4
Price Each US\$	217.55



**SEE burettes on page 33**



**Drying Rack High Impact Polystyrene**

**Kartell**

- Expandable, fasteners to connect additional racks included
- Interchangeable, removable pegs
- NEW Acrylic stand for our most popular drying rack

This 72 place drying rack is molded of high impact polystyrene. It comes supplied with 72 large pegs, draining tubes, fastening stoppers, and expansion hanging hooks which allow coupling with additional racks. The pegs are 4" long and the drip ledge measures 3".



**Drying Rack Stand, Acrylic**



Acrylic stand for our most popular drying rack! This sturdy stand is fabricated of 3/8" clear acrylic adding style and function to a normally wall mounted rack (259184-0000). The 4.5 lb stand includes all hardware needed to attach to the drying rack. The rack can be tilted up to 20° for added stability and ease of use. Rack can be used vertically or tilted to 20° for added stability and ease of use.



**Rodac Plate Rack**

Fabricated from clear acrylic which allows for full visibility from all sides. The posts are made of break-resistant polycarbonate, and are permanently fixed to prevent shifting of plates. A slide-down cover is provided to hold the plates down during transportation of the filled rack. Rodac Plate racks hold a total of 28 plates. Additional sizes available upon request.



103164	Rack for 60-65mm Dishes	\$64.47 each
103164-0001	Rack for 100mm Dishes	\$64.47 each

**Thermometer Rack HDPE**

Suitable for holding up to 25 thermometers in the correct vertical position, thus avoiding mercury separation, which may occur when thermometers are stored improperly. Manufactured from 1/4" high density polyethylene, the rack is sturdy and will not tip. Sides have large comfortable carry handles for easy transport of the thermometers. Hole diameters in top and middle plates 5/16". The bottom plate has convenient 1/8" drain holes. Overall dimensions are 8" W x 10" H x 5 3/4" D. Additional sizes available upon request.

103205	\$45.10 each
--------	--------------



## Sample Cup - Sampling



### Sample Cups PS

- For use in autoanalyzers

	202094	202114	202134	202044
Size ml	2.0	1.5	4.0	LDPE Stopper
Top Diameter mm	13	13	15	13
Bottom Diam. mm	13	13	12	N/A
Height mm	26	24	39	N/A
Case Quantity	1000	1000	1000	1000
Case Price \$	29.51	26.20	45.33	26.54

**Kartell**



### Sample Cups Storage Modules

Provides storage for hundreds of 13 mm sample cups in less than a square foot of space. Shelves are clear acrylic, base is white. Up to six holders can be stacked. An additional acrylic solid white cover is available for both the 50 and 100 cup rack. **Additional sizes available upon request.**



159545	-1	-2	-3	-4
Description	Module	Module	Cover	Cover
For	50 cups	100 cups	-0001	-0002
Length inches	8 1/4	8 1/4	8 1/2	8 1/2
Width inches	4 1/2	8 1/4	4 1/2	8 1/2
Depth inches	1 1/2	1 1/2	1	1
Case Quantity	12	12	12	12
Case Price \$	293.03	492.42	203.60	287.78



### Sample Cup Storage Unit Acrylic

- Complete unit holds 3200 sample cups (13mm)
- 16 storage compartments
- Sample Cup Storage Racks hold 200 cups each
- Mass storage for optimal organization of samples
- Unit fabricated of 1/4" white acrylic, racks of 3/16" clear acrylic
- Custom sizes and storage quantities available



Sample Cup Storage Racks hold most 13mm cups. If existing racks are being used in the Storage Unit, each compartment height measures 2.25".

159554	-0000	-0001
Description	Complete Unit	Sample Cup Storage Rack
Length inches	18	15.5
Width inches	21	10
Depth inches	16	1
Price Each \$	1,734.73	92.07



### Drum Sampler HDPE

Similar to the Liquid Sampler below, but specifically designed for easy, effective sampling of 55 gallon drums or vessels with openings as small as 2" ID. The included bottle (202445-0100 bottle on page 22) easily passes through the opening for quick filling. The handle prevents dropping of sampler into the opening of the drum. All rods are 1 1/4" O.D. **Additional sizes available upon request.**



114505-0100	Drum Sampler, 3' handle, 100mL	\$145.38 each
114515-0100	Drum Sampler - 6' handle, 100mL	\$179.07 each
114525-0100	Drum Sampler - 8' handle*, 100mL	\$223.33 each
202445-0100	100ml PP Graduated Bottle	\$327.79 case of 100

### Liquid Sampler HDPE

Manufactured from chemically resistant high density polyethylene, this sampling device is perfect for corrosive environments and for hard to reach places. The included bottle (202445-0500 bottle on page 22) screws into the end of the handle and is filled via four 5mm diameter ports (2 allowing liquid to enter and 2 allowing air to escape.) Excellent for industrial and environmental applications. All rods are 1 1/4" O.D. **Additional sizes available upon request.** \*2-piece handle for UPS shipment. **Please note: 500mL bottle does not fit through standard drum opening.**

114505-0500	Liquid Sampler, 3' handle, 500mL	\$145.38 each
114515-0500	Liquid Sampler - 6' handle, 500mL	\$179.07 each
114525-0500	Liquid Sampler - 8' handle*, 500mL	\$223.33 each
202445-0500	500ml PP Graduated Bottle	\$317.10 case of 50



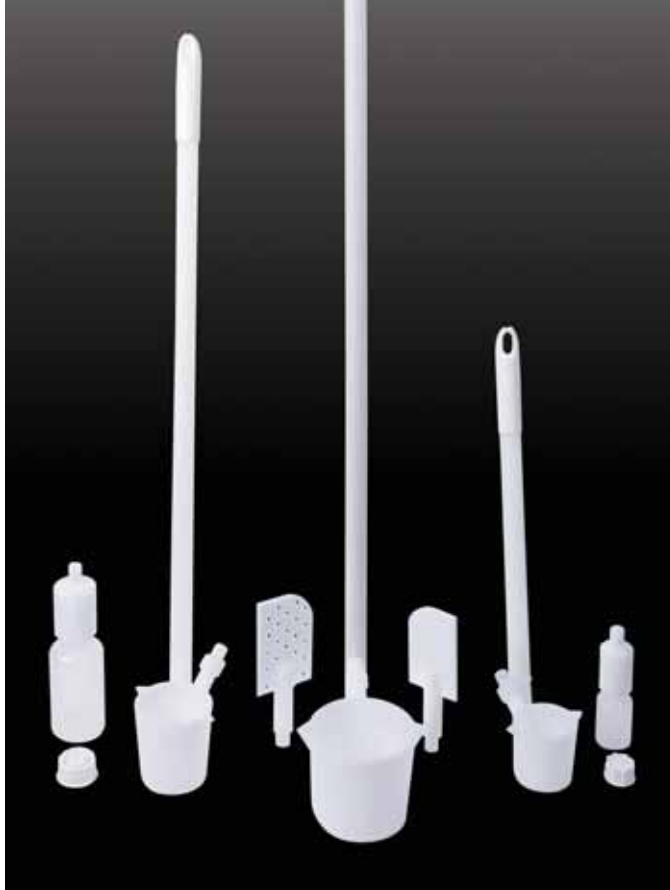

### Liquid Sampling & Stirring Kit, HDPE

- FDA Compliant HDPE
- Purchase individual components or as an entire kit
- Dipper kit includes 3 convenient handle lengths and 3 popular beaker capacities
- Stirrer kit includes 3 convenient handle lengths and two paddle heads
- Sampling kit includes 3 convenient handle lengths and 2 popular bottle capacities
- Mega kit includes 3 convenient handle lengths and all beaker, paddle and sampler options



Dynalon's new versatile modular liquid handling series fits all your needs. Whether sampling from drums or rail cars, stirring vats or dipping chemicals from a bath... we have the configuration to fill your requirements. Components are available piecemeal, as intuitive kits or buy the entire mega kit to cover all your bases. Inter changeable threaded components make using this product line quick, fun and easy!

Catalog Number	Description	UOM	Price
107035-1000	Dipper Sampling Kit (1 each below)		\$209.26
107035-0001	1.5' Handle	EA	35.89
107035-0002	3' Handle	EA	43.72
107035-0003	6' Handle	EA	55.27
107035-0004	250mL Dipping Beaker	EA	31.43
107035-0005	500mL Dipping Beaker	EA	32.46
107035-0006	1000mL Dipping Beaker	EA	38.90
107035-2000	Stirrer Kit (1 each below)		\$174.25
107035-0001	1.5' Handle	EA	35.89
107035-0002	3' Handle	EA	43.72
107035-0003	6' Handle	EA	55.27
107035-0007	Stirring Paddle	EA	23.55
107035-0008	Perforated Mixing Paddle	EA	35.18
107035-3000	Liquid Sampler Kit (1 each below)		\$259.86
107035-0001	1.5' Handle	EA	35.89
107035-0002	3' Handle	EA	43.72
107035-0003	6' Handle	EA	55.27
107035-0009	Sampler with Bottle 100mL	EA	62.53
107035-0010	Sampler with Bottle 500mL	EA	91.32
107035-5000	Complete Liquid Sampling & Stirring Kit (Consists of 1 each above -0001 to -0010)		\$378.34

## Sampling - Scoop

### Sampler/Ladle PTFE

This sampler-ladle is made from pure PTFE and is supplied with a fixed 6" (150mm) handle. Totally inert. 10ml capacity. Dimensions: top ID 1" and bottom OD is 3/4".

307014

\$182.51 pack of 4

### Scoop, PTFE

- Can be used with powders, granular solids and liquids
- Totally inert and non-contaminating

380145	-0001
Scoop Diameter mm	20
Width mm	30
Length mm	80
Price Each \$	44.22



### Large Scoop HDPE



Fabricated, heavy duty polyethylene scoop with many industrial applications. Large, approximately 1 gallon capacity. Bowl size is 7 1/2" x 10 1/2" with long 6 3/4" handle. Half-gallon scoop has bowl size 5 3/4" x 8" with 5 1/2" handle.

107154-0000	Large Scoop (1 gallon)	\$56.12 each
107154-0005	Small Scoop (1/2 gallon)	\$41.19 each



### Scoops/Ladles HDPE

High density polyethylene, high-temperature extra heavy duty bowl with securely welded solid handle. Handy for sampling and dispensing corrosive liquids. Note: 600ml size is graduated and supplied with 2 pour spouts. Additional sizes available upon request.



108085	-50	-100	-250	-600	-1000
Capacity ml	50	100	250	600	1000
Handle Length inches	9	9	9	10	12
Case Quantity	12	12	12	12	6
Case Price \$	150.19	162.20	177.31	194.96	226.43

## Scoop - Shield



### Scoops, Flat Bottom HDPE

Heavy duty scoops with many industrial and laboratory applications. Suitable for liquids and powders.

	606055	607105	606065	606075	607115
Bowl Length inches	2 1/2	3	4 1/4	5 1/4	5 3/4
Bowl Width inches	1 1/4	1 3/4	2 3/4	3	3 1/4
Liquid Capacity ml	15	25	65	110	150
Handle Length inches	1 3/4	2	2 3/4	3	3 3/4
Case Quantity	12	6	6	6	6
Case Price \$	19.15	11.75	14.81	19.42	32.68

	607135	607175	607145
Bowl Length inches	7 1/2	9 1/2	10 3/4
Bowl Width inches	4 3/4	6 1/4	6 3/4
Liquid Capacity ml	350	750	1250
Handle Length inches	4 1/4	4 1/2	5
Case Quantity	6	6	6
Case Price \$	67.26	126.71	242.27



### Volumetric Scoops, Flat Bottom PP

Autoclavable Polypropylene scoops shaped conveniently for sampling solids or liquids. Flat bottom with beveled angles for easy cleaning. Marked in milliliters. Suitable for foodstuff.

	208065	-0010	-0025	-0050	-0100	-0250	-0500	-1000
Length mm	32	43.8	55.4	67	94	112	141	
Width mm	103	137	163	201	261.5	315	386.6	
Height mm	16	21	26	34	43.7	55	69.4	
Liquid Capacity ml	10	25	50	100	250	500	1000	
Case Quantity	4	4	4	4	2	2	2	
Case Price \$	7.73	10.72	17.48	24.59	26.09	39.29	46.20	



### Scoops, Economy Round Bottom HDPE

**Kartell**

Designed for heavy industrial and laboratory applications, the round shape design facilitates complete transfer of the sampling material. Suitable for food grade products.

	208075	-0250	-0500	-1000	-1500
Capacity ml	250	500	1000	1500	
Case Quantity	5	5	5	5	
Case Price \$	42.86	51.54	71.52	79.15	



SEE  
Beta Radiation  
Protections  
Shields on  
pages 16 - 17

MADE IN  
U. S. A.  
172014

172284

### Bench Top Splash Shield

- No eye-level distortion
- Extra wide top

Lower bend and wider top gives greater visibility of work surface and assures greater protection from splashes to face and neck area. The Splash Shield has been designed to be used comfortably either from a standing or sitting position. The gentle bend from the base allows the technician to observe the working surface from a comfortable sitting position. The lower area of the Shield is just 12" wide, thus making it easy to reach behind the Shield to pipette, open vials or perform any number of functions, while protecting the operator from being accidentally splashed. Fabricated from 1/4" clear acrylic for excellent stability. Non-skid feet. Available in other sizes by special order. 172284 Measurements: base—20" W x 12" D; face area—20" W x 15" H; overall—20" W x 12" D x 20" H. 172014 Measurements: base—12.8" W x 8.2" D; face area—20" W x 14.75" H. Not suitable for radiation protection.

172284  
172014

Curved Splash Shield  
Single Angle Splash Shield

\$104.86 each  
\$62.70 each

## Shield - Slide Accessories



### Polycarbonate Safety Shield - NEW Design!

This shield is made from 1/4" thick polycarbonate. It will withstand temperatures up to +130°C and shields against UV. The shield is supported by a 12 pound industrial engineered weighted base. Dimensions: 30"H x 19"W x 6"D. [Additional sizes available upon request.](#)

172375



\$277.46 each

235305

235405

### Slide Staining Jar and Tray with Lid PMP

Molded, glass-clear PMP, these slide staining jars are for use with Cat. No. 235405 below and supplied with 2 lids. One lid for use when dish is not inserted providing for evaporation free storage of staining liquid and other lid with special opening to allow handle of staining dish to be inserted. Dimensions 235305: 81 x 101 x 86.5 mm. Staining dish made of autoclavable polypropylene with horizontal tray. The staining tray (235405) has 20 grooves and holds 20 slides 3" x 1" (76 mm x 26 mm). Removable snap-on handle. Dimensions 235405: 69.5 x 86 x 21 mm.

235305  
235405

Staining Jar with Lid  
Staining Tray

\$160.06 pack of 4  
\$77.29 pack of 4

**Kartell**



### Slide Block, Microscope HDPE

- Flat design adds stability

New improved flat design holds ninety one 1" x 3" slides (75-25mm). Block is chemically resistant, easy to clean and perfect for drying slides during evacuation and/or cleaning. Angled slots tip slides back for convenient viewing. Supplied with non-skid feet. [Additional sizes available upon request.](#)

135014	-0001	-0002
Holds # of Slides	90	45
Length inches	12	12
Width inches	7	4
Depth inches	2	2
Price Each \$	87.65	83.04



### Microscope Slide Tray

Molded of white PVC for easy distinguishing of different dyes on the slides. For storing of twenty standard slides 25 x 76 mm (1" x 3"). Designed for easy removal of slides.

201565

\$149.00 pack of 10

**Kartell**



### Slide Staining Jars PP

*Azlon*

A robust jar holding 10 slides, back to back, which is designed in a squared shape to conserve space and staining solution. With the cap removed the tops of the slides can be handled without touching the solution. The screw cap has a locating recess to support the slides and both body and cap have a molded-in lug to enable them to be wired together for transit. Dimensions: 80 x 33 x 30mm

535515-0001

\$76.23 pack of 4



### Staining Jar PMP

**Kartell**

These "glass-clear" staining jars are made of strong PMP and hold 26 x 76 mm (1" x 3") slides vertically. Eight grooves allow accommodation of 16 slides back to back. Supplied with molded PMP cover. Approximately 2" square at bottom x 2 1/4" square at top and 3 1/2" high. Packed 4 jars per case.

235505

\$91.92 pack of 4

## Slide Accessories



### Microscope Slide Staining Rack

Staining rack (235314-0001) for simultaneous staining of 25 slides; to fit staining trough (235314-0002). Can also be used also as mailing box.

235314-0001 Slide Staining Rack \$19.95 each  
 235314-0002 Slide Staining Trough \$50.70 each

**Kartell**



### Slide Tray for 100 Slides

Made of tough, resilient ABS for long life. Holds 100 standard 1" x 3" slides positioned vertically for easy insertion in prenumbered grooves allowing for simple identification and retrieval. Dimensions: 360 x 38 x 100 mm (14 1/4" x 1 1/4" x 3 1/4") height. Cover optional. Cover is made of clear polystyrene for full visibility. Protects slides when not in drawer (211654 or 211634 below) from dirt and dust.

211615 Slide Tray \$372.32 pack of 10  
 211605 Slide Tray Cover \$199.53 pack of 10

**Kartell**



### Slide Storage System 5-Drawer Storage Unit

An assembly of five (5) No. 211634 drawers (below) and one No. 211674 (below) cover providing secure storage for 5000 slides (with optional slide trays) in less than 4.5 cubic feet of space or simply a beautifully designed, functional storage unit which can be used for an endless number of storage purposes. Total outside dimensions of this unit on optional wheels is 16.5" x 16.5" x 30.75" high.

211654 Five Drawer Storage Unit \$530.21 each  
 211694 Optional Set of 4 Wheels \$36.73 each set

**Kartell**



### Drawer for Storage System

May be used to store 1000 slides in slide trays (optional see above 211615) or as convenient storage cabinet. Made of ABS. Dimensions of drawer inside are approximately 14.25" W x 14.25" L x 4.25" H.

211634 Drawer \$99.67 each  
 211674 Cover for Storage System \$64.27 each

**Kartell**



## Kartell

### Slide Dispenser, Automatic

Holds approximately 50 standard 3" x 1" (76 x 26mm) slides in transparent, dust-free container. By turning either side knob, the slides are ejected one at a time. Dimensions: 4 1/4" x 5" x 5 1/2" high.

245605 \$296.64 case of 6



### Microscope Covers

- Rigid dust covers great for use with various instruments
- Strong and lightweight

Round Cover: Rigid. Perfect for microscopes. Blocks out dust and corrosive fumes. Clear cellulose acetate with handle at top and firm aluminum bands at bottom. Square Cover: Versatile instrument cover, popular for balances. Clear cellulose acetate with handle at top and firm aluminum bands at bottom. Additional sizes available upon request.



	171015	171025
Description	Round	Square
Length inches	18	16
Width inches	10 diameter	11
Depth inches	N/A	10
Price Each \$	132.44	205.62



Tissue Embedding Cassettes, UNI Type

**Kartell**

Tissue embedding cassettes for paraffin inclusions, Universal type, provided with clip on closure lid that can easily be removed. They are available in six colors and delivered in cases of 500 pieces. Product Dimensions (l x w x h): 1.1" x 1.6" x 0.26"

230264	-000W	-000B	-000Y	-000G	-000P	-000R
Color	White	Blue	Yellow	Green	Pink	Red
Case Quantity	500	500	500	500	500	500
Case Price \$	86.12	86.12	86.12	86.12	86.12	86.12



Tissue Embedding Sponge

**Kartell**

Synthetic sponge with a calibrated porosity that can be easily inserted into the tissue embedding cassettes. Very useful for small specimens in biopsy tests. Product Dimensions (l x w x h): 1.2" x 1"

230264-0001	\$26.83 case of 500
-------------	---------------------



Tissue Embedding Rings ABS

**Kartell**

Embedding rings for use with Large Tissue Embedding Cassettes #230274 series. They are available in five colors and are delivered in cases of 500 pieces: Product Dimensions (l x w x h): 1.1" x 1.6" x 0.5"

230294	-000W	-000B	-000Y	-000G	-000P
Color	White	Blue	Yellow	Green	Pink
Case Quantity	500	500	500	500	500
Case Price \$	71.61	71.61	71.61	71.61	71.61



Tissue Embedding Cassettes, Mega Type

**Kartell**

Tissue embedding cassettes Mega type for medium-big dimensions samples. Provided with clip on closure lid that can easily be removed. They are available in five colors and delivered in case of 100 pieces. Product Dimensions (l x w x h): 1.1" x 1.6" x 0.54"

230274	-000W	-000B	-000Y	-000G	-000P
Color	White	Blue	Yellow	Green	Pink
Case Quantity	100	100	100	100	100
Case Price \$	35.64	35.64	35.64	35.64	35.64



Spatulas, PTFE

- 5mm thick for mixing & spreading
- Totally inert/non-contaminating

391945	-0120	-0180	-0240
Length mm	120	180	240
Width mm	12	20	30
Price Each \$	16.31	22.86	27.69



Metal Trays for Histology

**Kartell**

Made of stainless steel for easy removal of paraffin inclusions: they allow a precise location of the specimen into the paraffin. Product Dimensions (l x w x h): 2" x 1.4" x 0.5"

230314-0001	ID 0.9" x 1.4"	\$86.55 case of 10
230314-0002	ID 0.27" x 0.27"	\$86.55 case of 10



Spatula, Stirring Rod PP

**Kartell**

These white, one-piece polypropylene rods may be used as stirring rods. Policemen have two types of flattened ends which form small spatulas. 245mm (approximately 9 1/4") long.

212455	\$146.50 case of 70
--------	---------------------

## Spatula - Spot Plate



### Spatulas, PP

These polypropylene spatulas are autoclavable and have excellent chemical and heat resistance. Virtually unbreakable. Spatulas retain their original shape after flexing. Suitable for use with food products.

	391875	391895	391905	391915
Length mm	115	165	252	200
Case Quantity	48	48	50	48
Case Price \$	117.91	135.43	191.45	176.34



**SEE**  
Stirring Paddles  
& Scrapers  
on pages 68-69

490834



490864

### Spatula - Scraper

Nylon® or PE blade with white composition handle. A short handled unit specially designed as a scraper and spatula. Scrape and clean any hard to clean containers. 13 1/2" overall length. Blade is 4 1/2 wide, 7" long. Complete with large hand-grip.

490834	Rigid Blade (Nylon)	\$58.30 each
490864	Soft Blade (PE)	\$56.32 each



### Spot Plates PP

Comprises of 12 cavities, approximately 1 ml capacity. Is an economically priced, high quality, unbreakable spotting tile. Autoclavable.

55215	\$68.38 pack of 10
-------	--------------------

*Azlon*



### Spatula, Polyamide - 2 in 1 design

**Kartell**

These polyamide spatulas are glass fiber reinforced and are available in double spatula or a spatula spoon combination style. Polyamide is a very strong material with good chemical resistance against solvents; caution with acids and oxidizing agents.

391925	-0001	-0002	-0003
Description	Double spatula	Double spatula	Spatula/spoon
Length mm	150	180	180
Case Quantity	50	50	50
Case Price \$	101.01	104.67	121.74



### Spatulas/Stirrer Nylon®

Molded of Nylon®. Handy stirrer or spatula has wide thin blade 3 1/2" long, 1 3/4" wide. Overall length is 10". Packed 24 per case.

412575

\$96.20 pack of 24



### Spigots LDPE

Molded of low density polyethylene. No gaskets or inside threads to leak. Will fit standard threaded drums.

612935	Spigot White 3/4" IPS Thread	\$74.84 pack of 12
612945	Spigot Gold 2" IPS Thread	\$241.98 pack of 4

### Stainless Steel Sponge



Heavy-duty stainless steel sponges are the answer to removing hard to remove stains. Sponges are spun from a continuous strand of non-corroding, non-abrasive steel to withstand heavy use. Ideal for cleaning glass or stainless steel labware. Will not scratch glass or irritate your hands. 2 1/4" x 4" (approximate). Packed 2 to a bag, 12 bags (24 sponges) to a case.

416175

\$201.16 case of 24

### Spot Plates LDPE

**Kartell**

These spot plates have three depressions 21mm x 7mm deep. Tray is 28mm x 85mm. Made of low density polyethylene and will withstand temperatures to 80° C.

255225	\$71.22 pack of 40
--------	--------------------



**Octagonal Stirring Bar Kit PTFE**

Contains 16 octagonal stirring bars. Designed to meet your requirements for a variety of sizes, each kit contains 16 stirring bars packed in a reusable box.

Kit contains:

- (2) each 5/16x1/2" (8x13mm)
- (2) each 3/8x2" (9.5x51mm)
- (2) each 5/16x5/8" (8x16mm)
- (2) each 3/8x2 1/2" (9.5x64mm)
- (2) each 3/8x1" (9.5x25mm)
- (2) each 2x7mm Micro Bars
- (2) each 3/8x1 1/2" (9.5x38mm)
- (2) each 3x10mm Micro Bars

303595

\$93.37 each

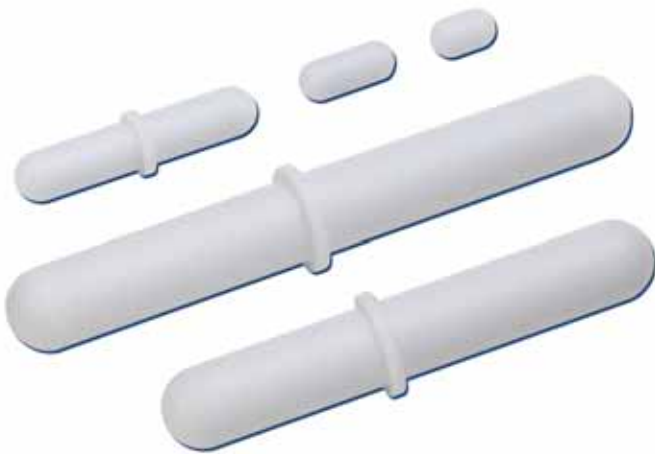

**Round Stirring Bars PTFE**

	303565	303575	303705*	303715*
Length mm	32	51	13	19
Length inches	1 1/4	2	1/2	3/4
O.D. mm	8	10	8	8
O.D. inches	5/16	3/8	5/16	5/16
Case Quantity	12	12	12	12
Case Price \$	76.72	127.72	56.64	58.83

\*without ring

	303725	303735	303745	303755
Length mm	25	38	42	75
Length inches	1	1 1/2	1 5/8	3
O.D. mm	8	10	10	12
O.D. inches	5/16	3/8	3/8	1/2
Case Quantity	12	12	12	12
Case Price \$	57.92	103.01	113.25	148.91

	303765	303775	303785
Length mm	102	127	150
Length inches	4	5	6
O.D. mm	16	16	19
O.D. inches	5/8	5/8	3/4
Case Quantity	10	10	10
Case Price \$	511.04	584.10	1,072.25

quality . value . service

**Stir Bar**



**Octagonal Stirring Bars PTFE**

- Our stir bars feature... ALNICO V magnetic cores which are one of the most powerful permanent magnet alloys available.
- Stir bars should not... be stored in a random mass or dropped on a hard surface, especially steel.
- Stir bars should... be stored in pairs to maintain magnetic strength.
- In general...PTFE thickness accounts for 18% of stir bar diameter .

303275	-0001	-0002	-0003	-0004	-0005	-0006
Length mm	22	13	13	15	25	28
Length inches	7/8	1/2	1/2	5/8	1	1 1/8
O.D. mm	8	3	8	8	8	8
O.D. inches	5/16	1/8	5/16	5/16	5/16	5/16
Case Quantity	12	12	12	12	12	12
Case Price \$	47.12	42.50	43.59	44.01	46.79	50.55

303275	-0007	-0008	-0009	-0010	-0011	-0012
Length mm	38	41	51	64	13	15
Length inches	1 1/2	1 5/8	2	2 1/2	1/2	5/8
O.D. mm	8	8	8	8	10	10
O.D. inches	5/16	5/16	5/16	5/16	3/8	3/8
Case Quantity	12	12	12	12	12	12
Case Price \$	52.85	62.23	65.98	111.16	50.55	56.64

303275	-0013	-0014	-0015	-0016	-0017	-0018
Length mm	22	25	35	38	48	51
Length inches	7/8	1	1 3/8	1 1/2	1 7/8	2
O.D. mm	10	10	10	10	10	10
O.D. inches	3/8	3/8	3/8	3/8	3/8	3/8
Case Quantity	12	12	12	12	12	12
Case Price \$	59.78	59.25	69.10	69.10	88.88	93.75

303275	-0019	-0020	-0021
Length mm	64	38	75
Length inches	2 1/2	1 1/2	3
O.D. mm	10	13	13
O.D. inches	3/8	1/2	1/2
Case Quantity	12	12	12
Case Price \$	105.15	144.57	192.55

**FREE**  
**Stir Bar sample pack**  
 Telephone 800-334-7585  
 or e-mail customer service at  
 dynaloninfo@dyna-labware.com



**Stirring Bars PTFE at Disposable Prices**

	303644	303664	303684	303694
Length mm	12	25	35	50
Length inches	1/2	1	1 3/8	2
O.D. mm	4	5.5	6	7.5
O.D. inches	3/16	3/16	1/4	1/4
Case Quantity	100	100	100	100
Case Price \$	206.16	278.86	312.67	421.14

## Stir Bar



### Egg Shaped Stirring Bars PTFE

303515	-0001	-0002	-0003	-0005	-0006
Length mm	20	25	30	40	50
Length inches	3/4	1	1 1/4	1 5/8	2
O.D. mm	10	12	16	20	20
O.D. inches	3/8	1/2	5/8	3/4	3/4
Case Quantity	12	12	12	12	12
Case Price \$	109.49	103.71	130.74	183.55	206.19

303515	-0007	-0008
Length mm	64	70
Length inches	2 1/2	3
O.D. mm	20	20
O.D. inches	3/4	3/4
Case Quantity	12	12
Case Price \$	271.09	329.92



### Extra Large Polygonal Stirring Bars PTFE

- Heavy duty for stirring large volumes of liquids on large magnetic stirrers

304445	-0001	-0002	-0003
Length mm	57	108	159
Length inches	2 1/4	4 1/4	6 1/4
O.D. mm	27	27	27
O.D. inches	1 1/16	1 1/16	1 1/16
Price Each \$	99.92	104.07	123.63



### Micro Stirring Bars PTFE

- For stirring test tubes, micro-beakers, etc...
- Covered with PTFE white resin

	303465	303475	303485	303495	303505
Length mm	15	8	7	10	12.7
Length inches	9/16	5/16	1/4	3/8	1/2
O.D. mm	1.5	1.5	2	3	3
O.D. inches	1/16	1/16	3/32	1/8	1/8
Case Quantity	12	12	12	12	12
Case Price \$	50.94	49.79	49.79	55.36	55.36



### Micro Color-Coded Stirring Bars PTFE

#### OCTAGONAL PTFE RED STIRRING BARS

304435	-0001	-0004	-0007	-0010	-0013
Length mm	8	5	7	10	12.7
Length inches	5/16	3/16	1/4	3/8	1/2
O.D. mm	1.5	2	2	3	3
O.D. inches	1/16	1/16	1/16	1/8	1/8
Case Quantity	12	12	12	12	12
Case Price \$	53.09	54.44	54.44	61.01	61.01

#### OCTAGONAL PTFE YELLOW STIRRING BARS

304435	-0002	-0005	-0008	-0011	-0014
Length mm	8	5	7	10	12.7
Length inches	5/16	3/16	1/4	3/8	1/2
O.D. mm	1.5	2	2	3	3
O.D. inches	1/16	1/16	1/16	1/8	1/8
Case Quantity	12	12	12	12	12
Case Price \$	52.08	54.44	54.44	61.01	61.01

#### OCTAGONAL PTFE BLUE STIRRING BARS

304435	-0003	-0006	-0009	-0012	-0015
Length mm	8	5	7	10	12.7
Length inches	5/16	3/16	1/4	3/8	1/2
O.D. mm	1.5	2	2	3	3
O.D. inches	1/16	1/16	1/16	1/8	1/8
Case Quantity	12	12	12	12	12
Case Price \$	52.08	54.44	54.44	61.01	61.01



### Octagonal Color-Coded Stirring Bar Kit PTFE

Contains 24 color-coded octagonal and micro stirring bars designed to meet your requirements for a variety of sizes packed in a reusable box.

Kit contains (length x O.D.):

- (1) EA Yellow, Blue & Red 1 x 5/16" (26x8mm)
- (1) EA Yellow, Blue & Red 2 x 5/16" (51x8mm)
- (1) EA Yellow & Red 3 x 1/2" (76x13mm)
- (2) EA Yellow, Blue & Red 5/16 x 1/16" (8 x 1.5mm)
- (2) EA Blue & Red 1/4 x 1/16" (7x2mm)
- (2) EA Yellow, Blue & Red 3/8 x 1/8" (10x3mm)

303795

\$169.85 each



Colored stir bars may leach in harsh chemicals.



**Octagonal Color-Coded Stirring Bars PTFE**

**OCTAGONAL PTFE YELLOW STIRRING BARS**

304405	-0001	-0002	-0003	-0004	-0005	-0006	-0007
Length mm	13	16	22	26	38	51	76
Length inches	1/2	5/8	7/8	1	1 1/2	2	3
O.D. mm	8	8	8	8	8	8	13
O.D. inches	5/16	5/16	5/16	5/16	5/16	5/16	1/2
Case Quantity	12	12	12	12	12	12	12
Case Price \$	54.47	56.64	61.01	63.17	75.44	83.90	210.25

**OCTAGONAL PTFE BLUE STIRRING BARS**

304415	-0001	-0002	-0003	-0004	-0005	-0006	-0007
Length mm	13	16	22	26	38	51	76
Length inches	1/2	5/8	7/8	1	1 1/2	2	3
O.D. mm	8	8	8	8	8	8	13
O.D. inches	5/16	5/16	5/16	5/16	5/16	5/16	1/2
Case Quantity	12	12	12	12	12	12	12
Case Price \$	54.47	56.64	61.01	63.17	75.44	83.90	210.25

**OCTAGONAL PTFE RED STIRRING BARS**

304425	-0001	-0002	-0003	-0004	-0005	-0006	-0007
Length mm	13	16	22	26	38	51	76
Length inches	1/2	5/8	7/8	1	1 1/2	2	3
O.D. mm	8	8	8	8	8	8	13
O.D. inches	5/16	5/16	5/16	5/16	5/16	5/16	1/2
Case Quantity	12	12	12	12	12	12	12
Case Price \$	54.47	56.64	61.01	63.17	75.44	83.90	210.25



**Cross Head Magnetic Stir Bar PTFE**

Greater mixing action at bottom, side, and top of container, even at low stirring speeds. No splashing, less noise. For test tubes, round bottom or flat bottom labware. PTFE resin with cross-shaped fins and encapsulated Alnico-V magnets.

304495	-0001	-0002	-0003	-0004	-0005	-0006	-0007
O.D. mm	10	14	17	22	30	35	58
Length mm	8	12	14	15	12	12	15
Case Quantity	12	12	12	12	12	12	4
Case Price \$	95.86	102.42	119.87	122.01	170.00	172.19	155.06

**Vane Bar PTFE**

Solid PTFE resin vanes with molded magnetic bars in center. Permit rotation in small conical tubes. Ensure thorough sample mixing.

304465	-0001	-0002
Description	Triangle	Half Round
For Use In	Vials	Test Tubes
	3-5ml	16mm
Case Quantity	12	12
Case Price \$	74.50	84.32

304465	-0003	-0004
Description	Round Tapered	Arrow
For Use In	Trim to fit various	Various
Case Quantity	12	12
Case Price \$	84.32	84.32

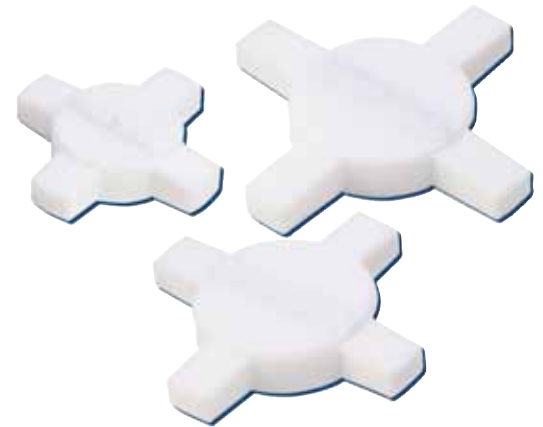

**Beaker Bar PTFE**

The Beaker Bar, magnetic stir bar, fits the inside diameter of the beakers indicated below. The Beaker Bars create a deep vortex even at low speeds.

303255	-0001	-0002	-0003
Beaker Capacity ml	100	250	400-500
Diameter mm	44	62	70
Price Each \$	27.72	36.86	39.73

**SEE beakers on pages 9-12**

## Stir Accessories



### Star Bar Stirring Heads PTFE

True paddle configuration in each magnetic PTFE stirring head. Excellent mixing at slow speeds for biological applications. Features larger vortex for more complete mixing. High strength Alnico-V magnet for maximum coupling. Autoclavable. Available as a kit of all five sizes or individually.

304455	-0001	-0002	-0003	-0004	-0005
Diameter mm	9.5	19	25	32	38
Diameter inches	3/8	3/4	1	1 1/4	1 1/2
Pack Quantity	12	12	12	12	12
Pack Price \$	89.85	109.49	112.80	131.52	153.33

304455 Set of 1 each size \$53.21 per set



### Triangular Stirring Bar PTFE

Designed to give the most efficient mixing of all stirring bars. These bars are uniquely designed in a triangular shape to give the best possible spinning action. Made of virgin PTFE with a strong, permanent alloy magnet.

	302806	302816	302826	302836
Length mm	12.5	25	35	50
Length inches	1/2	1	1 3/8	2
O.D. mm	6	6	9	12
O.D. inches	1/4	1/4	3/8	1/2
Case Quantity	12	12	12	12
Case Price \$	60.19	62.08	77.36	85.96

### Steel Core with Rounded Ends



### Solid PTFE with Flat Ends

### Stirring Rods

Available in two versions: Pure PTFE solid rod with tapered end, and pure PTFE with mild steel core. The version with steel core can be bent into a permanent shape. Inert and will not scratch, use up to 280°C. Approximately 1/2" O.D. (8mm)

### STIRRING RODS WITH ROUNDED ENDS - STEEL CORE

	303264	303284	303294	303294	303294
	-0000	-0000	-0000	-0001	-0002
Length mm	100	150	200	250	300
Length inches	3.9	5.9	7.9	9.9	11.8
O.D. mm	6	6	6	6	6
O.D. inches	1/4	1/4	1/4	1/4	1/4
Case Quantity	12	12	12	6	6
Case Price	105.59	110.60	133.85	75.25	81.83

### STIRRING RODS WITH FLAT ENDS - SOLID PTFE

303334	-0000	-0001	-0002	-0003	-0004
Length mm	100	150	200	250	300
Length inches	3.9	5.9	7.9	9.9	11.8
O.D. mm	8	8	8	8	8
O.D. inches	5/16	5/16	5/16	5/16	5/16
Case Quantity	12	12	12	6	6
Case Price	92.01	96.37	131.39	73.95	82.13

	212585	212595	212605	212615
Description	Two "U" fixed shaped blades	blade	Centrifugal blades	Centrifugal blades
Blade Width mm	40	65	60*	100*
Blade Height mm	15	78	26	39
Fits in Opening mm	40	65	26	29
Pack Quantity	5	5	5	5
Pack Price \$	114.85	120.49	164.31	229.51
	* fully extended			

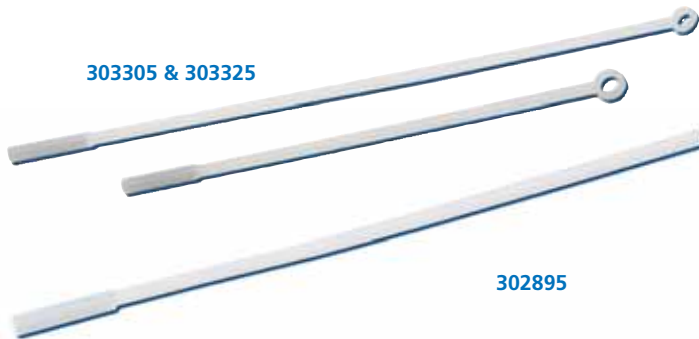

### 303305 & 303325

### 302895

### Stirring Bar Retrievers

Polypropylene Stirring Bar Retrievers: Ideal for use with all stirring bars. Entire retriever totally encased in chemically resistant polypropylene. Handy ring allows for hanging when not in use. PTFE Stirring Bar Retrievers: Permanent powerful magnet encapsulated in PTFE and supplied with flexible PTFE rod.

	303305	303325	302895
Material	PP	PP	PTFE
Length mm	456	304	330
Length inches	18	12	13
Pack Quantity	6	6	6
Pack Price \$	82.98	73.82	153.36



### Stirrers Polypropylene

The blades are made of chemically resistant polypropylene and are fixed to a PP-covered steel rod with a diameter of 8 mm (approximately 5/16") x 350 mm (approximately 13 3/4") long.

**Shaft Stirrer / Blades PTFE**

These stirrers are manufactured in a complete range of sizes and shaft lengths. They are inert, unbreakable, will not scratch and are useable to 260°C.

**SCREW PROPELLER**

312504	-0001	-0002	-0003	-0004
Shaft Diameter mm	6	6	9.5	9.5
Shaft Length mm	400	500	550	650
Rotor Diameter mm	40	40	60	60
Price Each \$	134.94	146.35	158.49	183.39

**ANCHOR PROPELLER**

312514	-0001	-0002	-0003	-0004	-0005	-0006
Shaft Diameter mm	6	6	9.5	9.5	9.5	9.5
Shaft Length mm	400	500	550	650	550	650
Rotor Diameter mm	80	80	100	100	140	140
Price Each \$	73.18	79.65	94.56	106.59	122.21	159.24

**CENTRIFUGAL PROPELLER**

312524	-0001	-0002	-0003	-0004
Shaft Diameter mm	6	6	9.5	9.5
Shaft Length mm	400	500	550	650
Rotor Diameter mm	50	50	70	70
Price Each \$	79.65	94.56	106.59	134.36

**SQUARE END**

312534	-0001	-0002	-0003
Blade Thick mm	3.2	3.2	3.2
Blade Wide mm	52	76	90
Blade Height mm	14	19	28
Price Each \$	8.55	10.46	12.26

**PLAIN END**

312544	-0001	-0002	-0003	-0004	-0005
Blade Thick mm	3.2	3.2	3.2	3.2	3.2
Blade Wide mm	65	75	105	125	150
Blade Height mm	25	25	25	25	25
Price Each \$	9.90	10.46	12.26	12.84	14.07

**SHAFTS ONLY FOR ABOVE BLADES**

312554	-0001	-0002	-0003	-0004
Shaft Diameter mm	6	6	9.5	9.5
Shaft Length mm	400	500	550	650
Price Each \$	67.65	73.18	82.50	106.59



**Magnetic Stirrer, Non-Electric**

**Kartell**

Unique stirrer, operated by water pressure between 15 and 40 psi, will work on air pressure as well. Stirs 500ml of water at 800 rpm with air at 8 psi or with water at 12 psi. Connects to pressure line with fitting supplied. No electric supply needed. All-plastic construction is corrosion-proof. No danger of explosion or shock. Can be used on a table or clamped to a stand with 1/2" diameter. Supplied complete with 6 ft. of vinyl tubing for inlet and outlet. Dimensions are 5" x 2 5/8" high.

204015

\$117.48 each

quality . value . service

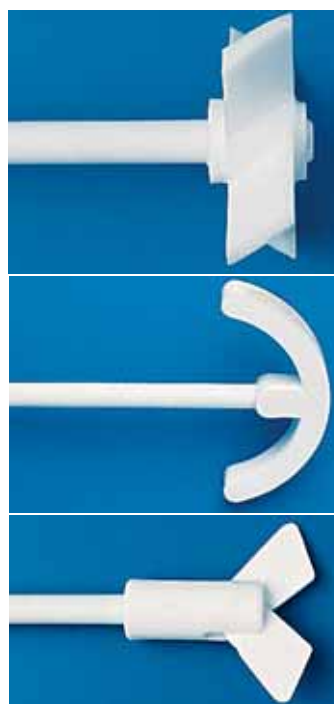

Screw Propeller

**SEE stir paddles on page 68**

Anchor Propeller



Square End

Centrifugal Propeller



Plain End



Stopcocks LDPE

Molded polyethylene stopcocks with ribbed handles requiring just a quarter turn to shut off flow. Key needs no lubrication. NOTE: Not intended for use in pressurized lines, maximum pressure 0.7 psi (50 cm of water). Available in two popular sizes.

	364605	364615
Fits Tubing I.D. mm	9	12
Fits Tubing I.D. inches	3/8	1/2
Length mm	82	98
Pack Quantity	6	6
Pack Price \$	80.20	98.87

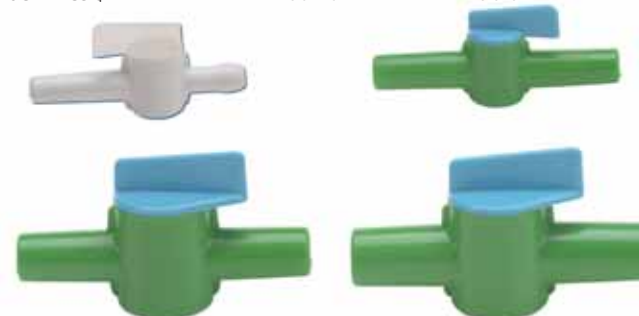

Miniature Stopcocks HDPE/PP

**Kartell**

The low friction properties of high density polyethylene allows for easy turning of PP key which requires no lubricant, thus eliminating blockage of the bores with grease. Straight bore. Ideal for liquids and gases under low pressure (operating pressure 7.25psi/0.5bar) or low vacuum.

	228255	228265	228275	228285
O.D. mm	8	10	13	15
I.D. mm	4.9	7	10.9	12.7
Material	PP	HDPE	HDPE	HDPE
Case Quantity	10	10	10	10
Case Price \$	21.88	22.65	26.42	26.42

## Swab - Tote Box



### Cotton Swabs

Disposable cotton swabs manufactured of USP grade purified cotton firmly attached to one end of wood shaft. May be autoclaved. Useful in bacteriology labs for inoculating broths, plated media or for obtaining culture specimens. Also useful for cleaning delicate instruments.

	394305	394325	394345	394365
Head Description	Regular	Pointed Small		Regular
Shaft Material	Wood	Wood	Wood	Wood
Length inches	2 3/4	3	6	6
Case Quantity	1000	1000	1000	1000
Case Price \$	29.14	32.14	34.11	32.78

### Enviro-Swabs™

Reticulated design is precision molded from superior grade, open cell polyurethane 100 ppi foam. Consistently demonstrating low particulation and chemical cleanliness. Enviro-Swabs are non-silicone formulated, hot-wire cut and slit (not die cut and sealed). A thermally bonded head to handle eliminates the use of adhesives for maximum reliability and performance. These swabs are non-linting and non-scratching. They may be used with alcohol, acetone, oils, greases and solvents.

	394085	394125	394145	394185	394225
Shaft Material	PP	Wood	Wood	PP	PP
Length inches	3	6	6	6	5
Case Quantity	500	500	500	500	500
Case Price \$	118.79	146.52	146.52	146.52	217.10



### Autoclave and Dry Heat Sterilization Tapes, 50 Meters

Use these tapes to enhance confidence that sterilization has occurred.

#202065 is used with autoclave sterilization (20 min. at +121°C or 10 min. at +125°C or 5 min. at +135°C). #202075 is for use with Dry Heat Sterilization.

Color changes from white to brown for both products. These tapes conform with ISO 11140/2005.

202065  
202075

Autoclave Sterility Tape  
Dry Heat Sterility Tape

\$24.59 per roll  
\$52.85 per roll



### Utility Pan LDPE

Molded of low density polyethylene. Extra sturdy with carrying handles on both ends. Dimensions: 14 1/2" x 12" x 6 1/4" deep.

409144

\$68.13 pack of 4



### DC Series DyNAcyclers

- DCL is perfect for Education or as a personal cycler
- DCR full sized workhorse



- Flexible block format
- Both come with a 4 year warranty

- Fast ramp times

**DyNAcyler DCL:** The Afon DCL 20, 25, 30 and 48 are designed with today's labs in mind. The user friendly programming can perform virtually any protocol, and the light weight and small footprint provide the lab with an essential yet compact unit.

**DyNAcyler DCR:** The Afon DCR60 and DCR96 are workhorses. The robust design, easy programming and 4 year warranty make this a high performance unit. Large, medium and small labs will find the DCR60 and 96 the perfect choice for the high demanding requirements of today's labs.

Visit [www.dynalon.com](http://www.dynalon.com) for Thermal Cycler product specifications.

DCL20	DyNAcyler DCL thermal cycler for 20 x 0.5ml microtubes, 120V/230V	\$2576.99 each
DCL25	DyNAcyler DCL thermal cycler for 25 x 0.2ml microtubes, 120V/230V	\$2576.99 each
DCL30	DyNAcyler DCL thermal cycler for 30 x 0.5ml microtubes, 120V/230V	\$2835.83 each
DCL48	DyNAcyler DCL thermal cycler for 48 x 0.2ml microtubes, 120V/230V	\$2835.83 each
DCR60	DyNAcyler DCR NON Gradient for 60 x 0.5ml microtubes, 120V/230V	\$4948.78 each
DCR96	DyNAcyler DCR NON Gradient for 96 x 0.2ml microtubes, 120V/230V	\$4948.78 each



**Tote Box HDPE**

Molded of high density polyethylene. Lightweight, but strong and durable. Chemically resistant to alkalis, oils, acids and detergents. Acceptable for use with food and food products. Tapered construction permits easy nesting.

	419244	419264
Description	Gray	Natural
Length inches	20	21 3/8
Width inches	12	15 1/2
Depth inches	6	6
Case Quantity	6	6
Case Price \$	130.82	152.39



**Deep Tray, HDPE**

- Low form and stackable, with handles for transporting and managing spills

208154	-0010	-0016	-0020
Capacity L	10	16	20
Length inches	12.2	13.8	16.1
Width inches	16.3	21.3	18
Height inches	3.8	4.5	5.6
Price Each \$	28.85	50.72	54.36



**NEW**

**NEW Autoclavable Deep Tote, PP**

Tough 12 liter autoclavable polypropylene tray for a variety of uses. Can hold 18 x 500 ml or 12 x 1 liter bottles. Tapered and stackable to save storage space. Product Dimensions (l x w x h): 20 x 13.8 x 4.1"

210505

\$31.50 each



**Utility Carrier HDPE**

Useful for carrying lab items, bottles, samples, cleaning aids, tools, etc. Molded-in center division and carrying handle. Dimensions: 17 5/8" x 12 5/8" x 9 1/4" high.

408164

\$82.14 pack of 6



Cover available for 410535

**Sterilizing Tote Boxes PP**

Molded of natural polypropylene. Suitable for food use. These tote boxes are chemically resistant to acids, alkalis, oils and detergents and will not rust or corrode. Can be nested when stored.

	410535	410535-1	410545	410555	410565
Length inches	12	Cover	19	20 1/4	15 1/4
Width inches	7 3/4	for	10 1/4	15 1/4	13
Depth inches	5 1/8	410535	5 1/8	5	7 7/8
Case Quantity	6	6	6	6	6
Case Price \$	92.29	82.98	161.02	221.01	211.99



**Deep Draining Tray, Low Form**

- HDPE

- Draining ports on all sides

Rectangular tank with draining ports on all sides. Stackable with recessed rim to allow ventilation. Useful for holding defrosting samples, plant cultures etc. Product Dimensions (l x w x h): 13.8" x 21.3" x 4.5"

209154

\$57.70 each

## Tote Box - Tray



### Translucent PP Pans with PP Lids

- Translucent polypropylene material allows for content visibility
- Withstands autoclavable temperature ranges from -40°F to 266°F (-40°C to 130°C)
- Non-stick smooth interior surface increases yield and eases cleaning

426444	-0002	-0004	-0006	-0008
Holding Capacity quart(s)	2.4	3.9	5.6	9.4
Length inches	6.9375	10.4375	12.75	12.75
Width inches	6.375	6.375	6.9375	10.4375
Case Quantity	6	6	6	6
Case Price \$	111.02	115.99	138.33	174.51

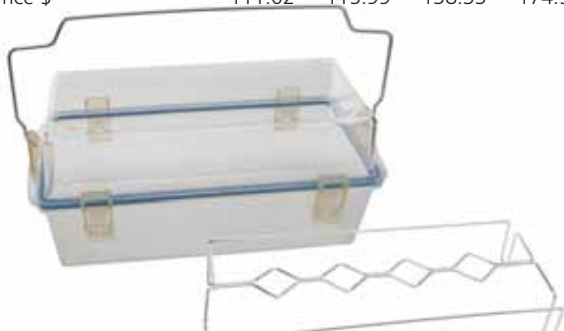

### Safety Box with Handle, Polycarbonate / Stainless Steel **Kartell**

- Completely Autoclavable
- Bio-hazard symbol on the box

Safety box is used to carry tubes or sample containers under safe conditions. Contains silicone gasket and 4 side-locks for security. Provided with a stainless steel handle and user sheet with instructions approved by WHO. Safety box rack is designed for 10 containers up to 200 ml size and 3 containers 30 ml size.

259955	-0000	-0003
Description	Safety Box	Safety box rack
Length inches	13	12.8
Width inches	6.9	6.7
Height inches	7.1	6.9
Price Each \$	127.62	44.93



### Round Bowl 10L PP **Kartell**

This autoclavable white bowl is a sturdy product. The rim helps contain contents. Two grips in the lower part of the rim aid carriage.

208135 \$15.09 each



**NEW**

**Kartell**

### **NEW** Stackable Trays, HDPE

Can be stacked to minimize storage space. High chemical resistance to organic and inorganic acids. Robust with lifting lugs and strengthening ribs to ensure long life.

219274	-0020	-0046
Capacity liters	20	46
Length inches	16.3	23.4
Width inches	12.4	14.4
Height inches	7.9	10
Price Each \$	45.70	85.30



**NEW**



### **NEW** Carboy Spill Containment Tray and Lab Organizer

- Designed for laboratory carboys or other large containers with spigots
- Trays are fabricated with 1/4" thick chemically resistant HDPE. All welded construction featuring a 1/2" skid resistant top shelf.
- Provides a safer way to dispense chemicals or other liquids in the lab
- Protects cabinets, laboratory benches and floors from liquid spills
- Each tray contains two convenient drain ports and 1/2" tubulation connection on lower trough
- Built-in lower bin for convenient storage of labware or accessories
- Built-in side handles for convenient transport
- 8" shelf height to accommodate up to a 5000mL beaker
- All trays are fabricated and tested in our Rochester, New York facility

Height: 13" / 330.2 mm  
 Width: 24.5" / 622.3 mm  
 Depth: 25" / 635 mm  
 Shelf: 24"W x 12"D / 609 x 305 mm  
 Tray (lower trough) capacity: 2 1/2 Gal / 10 L  
 Weight: 16 lbs / 7.25 Kg

107364

Carboy Spill Tray

\$354.00 each

**Rectangular Trays, PP & HDPE**

Heavy trays fabricated with 3/16" thick polypropylene or 1/4" high density polyethylene and feature an all welded construction. Dimensions listed are inner (I.D.). **Plastic trays below can be customized with spigots.** Additional sizes and materials available upon request.

PP TRAYS	107304	107314	107324	107334	107344	107354
Length inches	10	15	18	22	20	12
Width inches	15	20	18	26	20	16
Depth inches	3	3	4	4	6	8
Price Each \$	88.54	114.44	137.64	154.55	164.80	112.03

HDPE TRAYS	109874	108874-4	108874-5	108874-6	108874-7	108874-8
Length inches	15 1/2	22	18	18	12	16
Width inches	17 1/2	26	18	24	16	16
Depth inches	3	4	6	6	8	8
Price Each \$	67.82	97.40	94.74	101.51	78.85	98.79

HDPE TRAYS	109884	109894	109904	109914	109924	109934
Length inches	15 1/2	12	15 1/2	16	18	23 1/2
Width inches	17 1/2	16	17 1/2	20	22	29 1/4
Depth inches	4	3	5	4	4	3 1/4
Price Each \$	73.63	63.83	84.71	73.99	89.10	121.82



**Polypropylene 107304 with L730 Lid**



**High Density Polyethylene 108874-8**

**Rectangular Tray and Dispensing Tray Lids, PP & HDPE**

Shoebbox style tray lids are fabricated with 3/16" thick polypropylene or 1/4" high density polyethylene and feature an all welded construction. Additional sizes available upon request.

PP TRAY LIDS	L730	L731	L732	L733	L734	L735
To Fit Tray	107304	107314	107324	107334	107344	107354
Price Each \$	44.82	61.48	61.99	66.58	63.34	45.84

HDPE TRAY LIDS	L987	L887-4	L887-5	L887-6	L887-7	L887-8	L991	L992	L993
To Fit Tray	109874	108874-4	108874-5	108874-6	108874-7	108874-8	109914	109924	109934
	109884	108884-4	108884-5	108884-6	108884-1	108884-8	108884-2	108884-3	
	109904				108884-7				
					109894				
Price Each \$	50.95	73.10	65.85	68.98	49.42	50.44	52.02	68.47	77.28

All trays on this page are fabricated in our Rochester, NY facility and can be customized to your special requirements including spigots and tray covers.



**Round Trays and Round Tray Lids, PP & HDPE**

Fabricated trays of polypropylene are heavy wall (3/16"), corrosion resistant and may be autoclaved.

Fabricated trays of polyethylene are heavy wall (3/16"), corrosion resistant and durable. Dimensions listed are inner (I.D.). Additional sizes and materials available upon request.



**Dispensing Trays, HDPE**

Heavy trays fabricated with 1/4" thick high density polyethylene. All welded construction. Dispensing trays are supplied with polypropylene dispensing valve located as close to the tray bottom as possible, but can be in other locations upon request. Dimensions listed are inner (I.D.). Additional sizes and materials available upon request.

PP TRAY	109844	109854	109864
Diameter inches	10	15	20
Depth inches	3	3	4
Price Each \$	76.35	115.26	134.56

PP TRAY LID	L984	L985	L986
Price Each \$	44.33	47.42	58.69

HDPE TRAY	109804	109814	109824	109834
Diameter inches	12	15	18	24
Depth inches	3	3	4	6
Price Each \$	78.14	98.79	121.90	148.02

HDPE TRAY LID	L980	L981	L982	L983
Price Each \$	45.95	46.36	67.72	71.84

108884	-1	-2	-3	-4	-5
Length inches	12	16	18	22	18
Width inches	16	20	22	26	18
Depth inches	3	4	4	4	6
Price Each \$	89.86	102.89	108.03	133.35	130.85

108884	-6	-7	-8
Length inches	18	12	16
Width inches	24	16	16
Depth inches	6	8	8
Price Each \$	135.47	103.41	127.83

## Tray

**NEW**



### NEW Storage and Transport Trays PVC

**Kartell**

Useful for Lab and Desk Items. Very sturdy. Use for carrying items such as stir bars, connectors etc. Useful for knick knacks - rulers, erasers, pencils etc, in desk drawers. Central compartment of five cavity tray can be used for pipettes.

209304	-0005	-0012
Cavity	5	12
Cavity dimensions mm	100 x 185 (4) 100 x 385 (1)	90 x 90
Length mm	303	304
Width mm	403	404
Height mm	63	64
Price Each \$	53.85	58.25

### Flat Bottom Trays, White HDPE

- Easily cleaned
- Standard photographic paper size
- Pouring lip

	409204	409214	409224	409234	409244
Length inches	8.875	13.25	15.625	17.25	21
Width inches	6.875	11.25	13.375	14.375	17.5
Height inches	1.5	1.875	2.5	2.25	3.125
Price Each \$	9.38	17.50	27.30	28.70	45.50

	409254	409264*	409274*	409284*
Length inches	24	25.75	27.75	32.25
Width inches	20	21.75	23.5	27.5
Height inches	3	3.5	3.25	4.125
Price Each \$	58.10	86.81	95.20	134.88

\* No pouring lip



### High Impact Trays HIPS

**Kartell**

Useful for the transport and benchtop storage of vials, bottles, containers, instruments and various laboratory accessories. Made of food grade high impact polystyrene. Very durable.

209295	-0001	-0002	-0003	-0004	-0005	-0006
Length inches	7.9	5.9	13.9	13.9	16.1	16.1
Width inches	5.9	3.9	10	10	11.8	11.8
Height inches	0.83	1.2	1.6	3.2	0.8	3.2
Price Each \$	9.62	10.73	19.77	27.93	26.40	28.77

### Section Trays

Both sizes below interlock to help you organize supplies. Use separately or make an endless number of sections or combinations. Can be fitted in drawers, on shelves or benchtops. Each section hooks to the adjoining one so that they are never disarranged. Nestable to stack when not in use. White color.

	408095	408105
Length inches	9	12
Width inches	6	3
Depth inches	2	2
Case Quantity	12	12
Case Price \$	91.95	72.93





**NEW** Tray, Sample Bottle, PVC

**Kartell**

A strong PVC tray for holding sample bottles with base diameter not greater than 22 mm. Ideal for 7 ml (1/4oz) Bijou bottles or specimen tubes. Seen in photo are new blue closed Tuff vials, 5 & 10mL, # 626434. Each of nine rows can hold 12 to 15 of such bottles making a total capacity of 108 or more. Dimensions: 350 x 300 x 40mm.

259214

\$51.20 each

**NEW**



**NEW** Tray, Pipette 4 Place, PVC

**Kartell**

Designed to hold ~30 pipettes. 4 compartments accommodate pipettes of 1-2-5-10 ml capacities. Dimensions: 510 x 350 x 105mm.

211004

\$35.60 each



**Test Tube Stoppers LDPE**

**Kartell**

Single-position, tight-fitting, low density polyethylene plug-type stoppers to fit disposable test tubes.

**TEST TUBE STOPPERS LDPE 11-13mm**

276145	-0000	-000B	-000G	-000R	-000Y
Color	Natural	Blue	Green	Red	Yellow
Case Quantity	1000	1000	1000	1000	1000
Case Price \$	46.39	46.39	46.39	46.39	46.39

**TEST TUBE STOPPERS LDPE 15-17mm**

276155	-0000	-000B	-000G	-000R	-000Y
Color	Natural	Blue	Green	Red	Yellow
Case Quantity	1000	1000	1000	1000	1000
Case Price \$	52.12	52.12	52.12	52.12	52.12



**Test Tubes, PP w/ LDPE Screw Caps**

**Kartell**

16mm test tubes with quick closure screw caps; leakproof, and suitable for centrifugation 4000xg. Graduated in 2mL increments to 12mL. The design of the cap avoids any contamination due to drops of liquid on the inner surface.

299334	-000W	-000B	-000R	-000Y
Cap Color	White	Blue	Red	Yellow
Height mm	100	100	100	100
Diameter mm	16	16	16	16
Capacity mL	15	15	15	15
Pack Quantity	100	100	100	100
Pack Price \$	22.58	22.58	22.58	22.58



**Microcentrifuge Tubes PP - now available in packs of 500!**

- Leak tested to 20,000 RCF for 20 minutes at 20°C with an aqueous solution
- Attached lid provides a tight, leakproof seal, yet can be easily opened
- Lid membrane is uniformly thick to ensure trouble free piercing
- Available in a rainbow of colors for easy identification
- Supplied 1000 per case, 2 bags 500 each, except for Rainbow Pack
- All these premium tubes feature frosted writing area and graduations

**PREMIUM QUALITY 1.5ML MICROCENTRIFUGE TUBES PP**

399325	-0000	-0001	-0002	-0003
Color	Natural	Yellow	Blue	Green
Pack Quantity	500	500	500	500
Pack Price \$	16.31	18.95	18.95	18.95
Case Quantity	1000	1000	1000	1000
Case Price \$	35.41	42.49	41.12	41.12

**399325 -0004 -0005 -0006**

Color	Orange	Amber	Rainbow
Pack Quantity	500	500	
Pack Price \$	18.95	18.95	
Case Quantity	1000	1000	600
Case Price \$	41.12	41.94	26.69

**ECONOMY MICROCENTRIFUGE TUBES - NATURAL; 11,000 RCF Value**

299265	
Capacity ml	.5
Description	With Cap
Case Quantity	1000
Case Price \$	38.86



## Tube Rack



### Test Tube Racks HDPE

	416034	416044	416054	416064
Number of Tubes	Holds 12	Holds 12	Holds 17	Holds 12
Tube Size O.D. mm	20-22	18-20	10-14	28-32
Number of Spindles	5	5	5	0
Spindle Size inches	1/2	1/2	5/16	N/A
Length inches	8	8	7 1/4	10 1/2
Width inches	4	4	3 1/4	4
Height inches	2 3/8	2 3/8	2	2 1/8
Case Quantity	36	36	24	24
Case Price \$	572.55	572.55	408.66	512.40



### Test Tube Rack HDPE

**Kartell**

Lightweight, unbreakable test tube rack. Molded of high density polyethylene. Will withstand temperatures up to 110° C. Three-tier racks have legs to raise them from table. Excellent chemical resistance.

Description	259845	259865	259885	259925
2 tier	3 tier	3 tier	3 tier	3 tier
Holds # of Tubes	10	12	12	24
Tube Size mm	18	12	19	19
Length inches	9 3/4	7 1/2	7 1/2	15
Width inches	2 3/8	2 3/8	2 3/8	2 1/2
Depth inches	2 7/8	3 1/8	3 1/8	3 1/2
Pack Quantity	5	5	5	5
Pack Price \$	79.6	92.64	93.07	186.13



classroom work. There are six drying pegs on the front of the stand which is supplied flat and is very easy to assemble for use or disassemble for storage.

516075

\$56.60 pack of 6

*Azlon*

### Test Tube Rack, Kit Form HDPE

This simple rack has 6 holes of 25mm diameter and its shape ensures good visibility making it ideal for



225665-0002



225645-0000



225655-0001

### Wet/Dry Test Tube Racks PP

**Kartell**

- Solid High Density PP; Autoclavable at 121°C
- Will not rust or corrode makes epoxy-coated wire racks obsolete
- Supplied flat for economical storage and shipping
- Can be used dry or wet in waterbaths

These racks for tubes up to 13mm provide excellent stability with no tendency to float or move in circulating water baths. An alpha numeric grid reference on the top tier enables precise location in the rack of particular samples. Available in three colors for easy identification. Shipped flat, easily and permanently snapped together to save shipping expense and reduce shelf space needed in storerooms.

225645	-0000	-0001	-0002
Color	White	Red	Blue
Holds # of Tubes	90	90	90
Size of Tubes mm	13	13	13
Case Quantity	5	5	5
Case Price \$	79.31	79.31	79.31

225655	-0000	-0001	-0002
Color	White	Red	Blue
Holds # of Tubes	60	60	60
Size of Tubes mm	16	16	16
Case Quantity	5	5	5
Case Price \$	79.31	79.31	79.31

225665	-0000	-0001	-0002
Color	White	Red	Blue
Holds # of Tubes	40	40	40
Size of Tubes mm	20	20	20
Case Quantity	5	5	5
Case Price \$	79.31	79.31	79.31

### Smooth Rack, PP

Tubes stay put in the new SMOOTH RACK and will never slip into an adjacent position! Each Smooth Rack accommodates up to 72 tubes from 10 to 16mm in diameter, adding ease and convenience to your daily efforts. Made from autoclavable polypropylene, choose either blue or white.

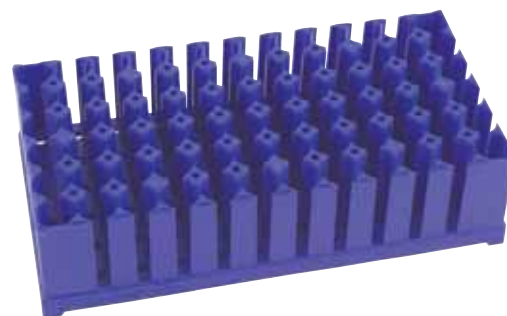

416084	-000B	-000W
Description	Blue	White
Length inches	9.7	9.7
Width inches	5.0	5.0
Height inches	2.6	2.6
Price Each \$	25.78	25.78



**Test Tube Supports**

Test Tube Supports for 10, 13, 16 and 20 mm tubes. Acrylic units have clear shelves with white sides and bases. [Additional sizes available upon request.](#)

159505	-01	-02	-03	-04	-05
Holds # of Tubes	15	18	20	24	48
Tube Size mm	10	13	13	13	13
Case Quantity	12	12	12	12	12
Case Price \$	301.79	353.59	358.79	395.31	263.31

159505	-06	-07	-08	-09	-10
Holds # of Tubes	72	100	144	12	18
Tube Size mm	13	13	16	16	16
Case Quantity	6	4	4	12	12
Case Price \$	321.64	154.79	343.19	300.86	338.33

159505	-11	-12	-13	-14	-16
Holds # of Tubes	20	24	48	72	100
Tube Size mm	16	16	16	16	16
Case Quantity	12	12	6	6	4
Case Price \$	376.15	395.42	298.69	321.64	318.89

159505	-17	-20	-21
Holds # of Tubes	144	24	48
Tube Size mm	16	20	20
Case Quantity	4	12	6
Case Price \$	352.34	411.25	292.98



**Refrigerator-Freezer Storage Rack**

Clear acrylic racks for storage of 16mm specimen tubes for refrigerator or freezer. Rack allows sufficient space for labeling of individual specimen tubes. Rack is sized to utilize available space efficiently and have hand grips. [Additional sizes available upon request.](#)

159515	-0000	-0001	-0002	-0003
Holds # of Tubes	225	100	200	300
Length inches	14	9 1/2	18 1/2	27
Width inches	14	9 1/2	9 1/2	9 1/2
Depth inches	2 1/2	2 1/2	2 1/2	2 1/2
Price Each	112.99	106.92	112.99	135.24



**Microcentrifuge Tube Racks HDPP**

**Kartell**

For 1.5 ml micro test tubes available in four colors. Can accommodate 50 micro tubes with lid open (without interfering) or 100 micro tubes with lid closed or without lids. Racks are stackable even when completely loaded with test tubes.

225675	-0000	-0001	-0002	-0003
Color	White	Red	Blue	Yellow
Pack Quantity	5	5	5	5
Pack Price \$	103.76	103.76	103.76	103.76

**SEE**  
**Microcentrifuge Tubes on page 95**



**Microcentrifuge Tube Rack PP**

- Step design for easy viewing
- Two sizes: 1.5ml or 0.5ml

Racks allow storage of 20 micro test tubes and are available in two models, one for 1.5 ml tubes and one for 0.5 ml tubes. Top step is numbered from 1 to 10, lower step is numbered from 11 to 20. Made of autoclavable polypropylene. Each rack measures 206 x 88 x 47 mm (approximately 8 1/8" x 3 1/2" x 1 7/8"). Hole I.D. for 1.5ml tube rack is 1/4" and for 0.5ml tube rack is 3/8".

202965-0001	Rack for 1.5ml tubes	\$92.08 pack of 6
202965-0002	Rack for 0.5ml tubes	\$92.08 pack of 6

## Tube Rack



159565-0001

159565-0003



### Blood Bank Cross Match Holders

These racks are manufactured of clear acrylic shelves with white bases and sides. For typing, screening and other blood bank applications. For blood donor processing. Holds donor sample tubes as well as tubes for donor's serum and cell suspension, ABO, Rh, antibody grouping and screening. [Additional sizes available upon request.](#)

159565	-01	-02
Total # of Tubes	24	29
Tube Breakdown	4:16mm sample tubes 20:10mm cross-match	1:16mm sample tubes 1:13mm pilot tube serum 27:10mm phenotype, genotype and cross match tubes
Length inches	11 1/2	8 3/4
Width inches	2 1/2	2 1/2
Depth inches	2 1/2	2 1/2
Price Each \$	29.01	29.57

159565	-0003	-0004
Total # of Tubes	38 (for five sets of tubes with printed identification on top panel)	90
Tube Breakdown	<b>Set 1</b> - 1:16mm patient, 1: Serum tube, 1: Cell suspension tube <b>Set 2</b> - 4:10-14mm Forwarding group tubes <b>Set 3</b> - 3: Reverse grouping tubes <b>Set 4</b> - 16: Major cross-match tubes <b>Set 5</b> - 12: Minor cross-match tubes	6:16mm Donor sample tubes 84:10-13mm Donor serum and cell suspension, ABO, Rh, antibody and screening
Length inches	10	13 1/4
Width inches	3 3/4	5 1/4
Depth inches	2 1/2	2 1/2
Price Each \$	39.05	85.84



### Safety Centrifuge Tube Rack and Box with Cover

- Protect samples from dust or frost
- Made of tough Polycarbonate with transparent hinged removable PC cover
- Temperature Range: ~ -130°C to +130°C
- Includes two PC racks with alpha numeric grid for 15mL and 50mL tubes
- Holds 20 x 15mL tubes or 12 x 50mL tubes
- Draining holes in bottom allow usage in Water Bath
- Compact and stackable, easy to transport safely
- Dimensions: 150 x 117 x 127mm (l x w x h)

459945

\$35.00 each



### Tube Rack, Hybridization

Sturdy acrylic racks organize and store hybridization tubes before and after incubation. They are perfect for holding tubes during membrane preparation and filling with hybridization solutions. [Additional sizes available upon request.](#)



159534	-0001	-0002	-0003
Holds # of tubes	6	6	4
Tube Size mm	38	44	80
Length inches	10.5	10.5	12
Width inches	7.5	7.5	7.5
Depth inches	5.5	5.5	5.5
Hole Diameter inches	1.62	1.75	3.15
Price Each \$	135.38	135.38	135.38

## Tube Rack Holder - Tubing



### Rack Holder

This clear acrylic rack holder is suitable for use on a bench top or in a freezer to maximize use of space. This rack holder has four shelves to hold eight trays including fraction collector trays. It can fit many different racks. The dimension of 172175 holder is 6 1/2"W x 9"D x 9"H. Compartment dimensions for 172175 are 6"W x 8 1/2"D x 2"H.



The dimension of 172175-0001 rack holder with included rack is 9 7/8"W x 11"D x 13.25"H. Each 172175-0001 rack is supplied with one 225675-0003 (yellow) microcentrifuge tube rack from page 97. Compartment dimensions for 172175-0001 are 9 3/8"W x 10.75"D x 3"H. Both rack holders are supplied with non-skid feet. [Additional sizes available upon request.](#)

172175	Rack Holder	\$106.49 each
172175-0001	Rack Holder with rack	\$106.49 each

- General: Meets or exceeds the requirements listed in ASTM D 3296-03
- Temperature: -100°F to 400°F
- Flammability: UL 94 VO rated. FEP resists combustion and does not promote flame spread
- FDA: FEP is approved for use in food contact applications in compliance with FDA regulation: 21 CFR 177.1550.
- USP CLASS VI: Altafluor 200 meets the requirements of USP Class VI

### Tubing FEP Fluoropolymer

- 100% Virgin grade high performance resins used to resist stress cracking
- Chemically inert to most industrial chemicals and solvents
- High thermal stability
- Low permeability
- FDA compliant for food contact
- Superior electrical insulation properties
- Excellent UV transmission
- Moisture absorption nearly 0
- Non-flammable

FEP (fluorinated ethylene propylene) is an economical choice for applications requiring chemical resistance in combination with broad temperature exposure. ALTAFLUOR 200™ FEP offers excellent clarity which makes it ideal for sight glass/flow monitoring applications. Additionally, the outstanding UV transmission rate of FEP makes it a clear choice for UV transmission applications. ALTAFLUOR 200™ tubing may be used with flare or conventional fittings. Additional sizes and heavy duty product available upon request.

610875	-0001	-0002	-0003	-0004	-0005
I.D. inches	1/16	1/8	3/16	1/4	5/16
OD inches	1/8	3/16	1/4	5/16	3/8
Variance +/-	0.004	0.004	0.004	0.004	0.004
Wall inches	0.030	0.030	0.030	0.030	0.030
Variance +/-	0.003	0.003	0.003	0.003	0.003
Feet Per Pack	25	25	25	25	25
Pack Price \$	39.02	54.39	72.83	94.94	109.25



### Vinyl Laboratory Tubing

- Non-toxic
- Smooth & flexible
- Transparent & inert
- Chemical resistant

#### Physical Properties

Specific Gravity	1.20	Color	Clear
Tensile Strength	2000 psi	Toxicity	Non-toxic
Elongation%	400%	Aging Characteristics	Excellent
Durometer Hardness, Shore A	68	Temperature Resistance	212°F
Brittle Temperature °C	-40°C		

Technical data provided is based on individual laboratory and test reports and is accurate to the best of our knowledge. No guarantees are expressed or implied. Dynalon® Vinyl Food Grade Tubing is designed for use in the laboratory. Glass-like transparency; smooth, dense bore will not harbor bacteria or provide a surface receptive to sediment build-up. Conforms to all FDA, USDA and 3-A milk handling standards. May be steam sterilized.

610855	-02	-03	-04	-05	-06
I.D. inches	1/8	3/16	3/16	3/16	1/4
O.D. inches	1/4	5/16	3/8	7/16	3/8
Wall Thickness inches	1/16	1/16	3/32	1/8	1/16
Feet Per Case	50	50	100	100	50
Case Price \$	21.00	26.98	75.66	122.64	33.32

610855	-07	-08	-09	-10	-11
I.D. inches	1/4	1/4	5/16	5/16	5/16
O.D. inches	7/16	1/2	7/16	1/2	9/16
Wall Thickness inches	3/32	1/8	1/16	3/32	1/8
Feet Per Case	50	50	50	100	100
Case Price \$	49.50	71.11	44.98	129.65	147.81

610855	-12	-13	-14	-15	-16
I.D. inches	3/8	3/8	3/8	7/16	7/16
O.D. inches	1/2	9/16	5/8	9/16	5/8
Wall Thickness inches	1/16	3/32	1/8	1/16	3/32
Feet Per Case	50	50	50	100	100
Case Price \$	47.71	68.38	94.48	113.42	144.01

610855	-18	-19	-20	-25	-26
I.D. inches	1/2	1/2	1/2	5/8	5/8
O.D. inches	5/8	11/16	3/4	13/16	7/8
Wall Thickness inches	1/16	3/32	1/8	3/32	1/8
Feet Per Case	50	50	50	50	50
Case Price \$	57.58	85.53	115.21	113.42	151.23

610855	-31	-33	-35	-37	-38
I.D. inches	3/4	7/8	1	1	1 1/4
O.D. inches	1	1 1/8	1 1/4	1 3/8	1 3/4
Wall Thickness inches	1/8	1/8	1/8	3/16	1/4
Feet Per Case	50	50	50	50	50
Case Price \$	171.00	252.00	260.11	324.00	522.00



SEE  
Tubing Cutters  
on page 100

# Tubing - Tubing Accessories



## ESCO Medical Grade Tubing

- High quality non-toxic silicone tubing or medical, pharmaceutical and food applications
- Peroxide-cured tubing
- Full traceability via batch code information discretely laser etched along full length of tubing

- Tamper evident labeling on outer box
- Suitable for use with peristaltic pumps
- Suitable for autoclaving or dry heat sterilization
- Manufactured under clean room (Class 7) conditions
- Available in a wide variety of bore sizes and wall thickness
- Supplied in 15 Meter (49.21') coils\*

### Certification:

USP Class VI  
 FDA CFR 177.2600  
 Food Contact  
 European Pharmacopoeia 3.1.9  
 ISO 10993-1.1992  
 BS2775 Dimensional Tolerances  
 BS2848 Electrical Standard

Characteristic	Value
Shore hardness	.60 Shore A
Color	.Translucent
Tensile strength	.10 MPa
Elongation	.500%
Tear resistance	.38KN/m
Max. recommended operating temperature	.200°C
Min. recommended operating temperature	.-50°C
Specific gravity	.1.15g/cm3

Item Number	Bore mm	Wall mm	O.D. mm	Length M	Price \$
TSR0050050P	1.5	1.0	3.5	15	58.71
TSR0150100P	1.5	1.0	3.5	15	71.98
TSR0200050P	2.0	0.5	3.0	15	93.57
TSR0200100P	2.0	1.0	4.0	15	81.04
TSR0250100P	2.5	1.0	4.5	15	80.85
TSR0400160P	4.0	1.6	7.2	15	95.09
TSR0500160P	5.0	1.6	8.2	15	97.63
TSR0550160P	5.5	1.6	8.2	15	120.87
TSR0550250P	5.5	2.5	10.5	15	155.12
TSR0600200P	6.0	2.0	10.0	15	116.81
TSR0800160P	8.0	1.65	11.2	15	224.14
TSR0800200P	8.0	2.0	12.0	15	144.84
TSR0900250P	9.0	2.5	14.0	15	343.78

\*ESCO medical grade tubing is non-stock. 4 to 6 week lead times may apply. Additional sizes of ESCO tubing may be available upon request.



## Tubing LDPE

Non-toxic, translucent virgin polyethylene. Contains no plasticizers, chemically inert. Not affected by most acids or alkalis. Will remain flexible with aging. 612484 is a special small bore tubing.

612475	-0001	-0002	-0003	-0004	-0005
I.D. mm	3	4	7	10	13
Wall mm	2	2	2	2	2
Feet Per Pack	100	100	100	100	100
Pack Price \$	30.02	59.64	52.20	66.59	132.63

612475	-0007	-0008	612484
I.D. mm	19	26	.045"
Wall mm	3	3	.140"
Feet Per Pack	100	100	100
Pack Price \$	253.03	450.01	25.22



## Connector Stopper 29/32 PP

Stoppers with tubing connections Standard taper 1:10 ensuring perfect sealing action. Hose adapters are Ø mm 8 (~5/16") - Length 20 mm.

228205 \$12.65 each



## Quick Disconnects LDPE



These polyethylene quick disconnects are useful for joining tubing of glass, rubber, or plastic. Connectors fit tightly together. They are tapered to accommodate a range of diameters. Replaces expensive adapters. Reducing connectors can be made by combining:

- No. 228705 with 228715 to accept 4-5-6-7-8 mm I.D. tubing
- No. 228725 with 228765 to accept 8-9-10-11-12 mm I.D. tubing
- No. 228775 with 228785 to accept 12-13-14-15-16 mm I.D. tubing

	228705	228715	228725	228765
Fits Tubing I.D. inches	1/8-7/32	3/16-5/16	1/4-3/8	3/8-7/16
Fits Tubing I.D. mm	4-6	6-7-8	8-9-10	10-11-12
Case Quantity	100	100	100	100
Case Price \$	147.25	161.10	168.55	201.45

	228775	228785
Fits Tubing I.D. inches	7/16-9/16	1/2-5/8
Fits Tubing I.D. mm	12-13-14	14-15-16
Case Quantity	100	100
Case Price \$	239.75	258.12



## Tubing Cutter

Edges cut with the hose cutter are always clean and flat, even in the case of thick hoses.

610924 \$21.13 each

**Tubing Connectors and Adapters PP**

- Excellent chemical resistance
- Autoclavable Polypropylene

- Serrated connecting surfaces to prevent tubing slippage
- Adapters allow for connecting different diameter tubing

**Kartell**

STRAIGHT CONNECTOR	227235	227245	227255	227265	227275	227285
Fits Tubing I.D. inches	1/8-7/32	3/16-7/32	1/4-3/8	3/8-7-16	7/16-9/16	1/2-5/8
Fits Tubing I.D. mm	4-6	6-7-8	8-9-10	10-11-12	12-13-14	14-15-16
Case Quantity	100	100	100	100	100	100
Case Price \$	89.80	114.65	119.81	112.97	145.22	155.62

TUBE ADAPTERS	227545	227555	227565
Connects I.D. inches	1/8-5/16 to 1/4-7/16	1/8-5/16 to 7/16-5/8	1/4-7/16 to 7/16-5-8
Connects I.D. mm	4-6-8 to 8-10-12	4-6-8 to 12-14-16	8-10-12 to 12-14-16
Length mm	86	86	92
Case Quantity	100	100	100
Case Price \$	198.01	213.19	230.49

227265

227545



**Check Valve PP**

Valve prevents the Reverse flow of the liquid when the pressure is interrupted. Useful for any tubing system on vacuum line. Regular size valve will fit tubing 8-9-10 mm (1/4" to 3/8") diameter depending on elasticity. Large size valve will fit tubing 12-13-15 mm (7/16" to 5/8") diameter. Will withstand temperatures up to 100° C.

**Kartell**

228225  
228215

Check Valve  
Large Check Valve

\$211.75 pack of 50  
\$285.86 pack of 50

**FREE**  
Tubing Connector Sample Pack  
Telephone 800-334-7585  
or e-mail dynaloninfo@dyna-labware.com

**Tubing Connectors PP**

- Excellent chemical resistance
- Serrated connecting surfaces to prevent tubing slipping
- The elasticity of the tubing will influence choice of size
- Autoclavable polypropylene
- Withstands flows to 20 p.s.i.
- Dimensions listed are nominal

"Y"	222545	222555	222565	222575	222585	222595	222605
Fits Tubing I.D. inches	1/8-5/32	3/16-7/32	1/4-5/16	3/8	7/16	1/2-9/16	9/16-5/8
Fits Tubing I.D. mm	4	6	8	10	12	14	16
Case Quantity	100	100	100	100	100	100	100
Case Price \$	118.29	136.42	142.92	193.81	210.95	222.48	266.95

4-WAY	222925	222935	222945	222955	222965	222975
Fits Tubing I.D. inches	1/8-5/32	3/16-7/32	1/4-5/16	3/8	7/16	1/2-9/16
Fits Tubing I.D. mm	4	6	8	10	12	14
Case Quantity	100	100	100	100	100	100
Case Price \$	172.90	176.85	216.59	250.18	279.47	321.34

"T"	227905	227915	227925	227935	227945	227955	227965
Fits Tubing I.D. inches	1/8-5/32	3/16-7/32	1/4-5/16	3/8	7/16	1/2-9/16	9/16-5/8
Fits Tubing I.D. mm	4	6	8	10	12	14	16
Case Quantity	100	100	100	100	100	100	100
Case Price \$	118.29	136.42	142.92	193.81	219.24	222.48	269.71

EQUAL ANGLE "Y"	227005	227025	227045	227065	227085	227105
Fits Tubing I.D. inches	1/8-7/32	3/16-7/32	1/4-3/8	3/8-7-16	7/16-9/16	1/2-5/8
Fits Tubing I.D. mm	4-6	6-7-8	8-9-10	10-11-12	12-13-14	14-15-16
Case Quantity	100	100	100	100	100	100
Case Price \$	224.51	262.97	275.59	312.49	333.43	365.47

"L"	227165	227175	227185	227195	227205	227215	227225
Fits Tubing I.D. inches	1/8-5/32	3/16-7/32	1/4-5/16	3/8	7/16	1/2-9/16	9/16-5/8
Fits Tubing I.D. mm	4	6	8	10	12	14	16
Case Quantity	100	100	100	100	100	100	100
Case Price \$	61.99	80.34	101.30	118.79	132.83	149.33	181.62

SEE Tubing on pages 99-100

**Kartell**



## Tubing Accessories



### Tubing Connector Kit

Kit consists of 55-piece assortment of connectors and clamps needed in daily lab routine or for industrial application. Supplied in handy plastic compartment tray.

Kit includes:

14 Y Connectors . . . . .2 ea size 3 Dura Clamps . . . . .1 ea size  
 14 T Connectors . . . . .2 ea size 12 Quick Disconnects . . .2 ea size  
 12 Straight Connectors .2 ea size

680505

\$108.09 each

## Kartell



670715

670755



670725

### Dura-Clamp® Tubing Flow Valve

- Easily operated with one hand
- One piece plastic construction – will not rust or corrode

	670715	670755	670725
Accepts Tubing OD	up to 1/4"	1/8" to 1/2"	up to 3/4"
Description	Mini, PP	Standard, PP	Maxi, Polyester
Case Quantity	100	25	6
Case Price \$	15.57	17.81	14.87

SEE  
Tubing on pages 99 - 100



### One Position Clamp PP

This unique open/close, single position design allows for positive on/off flow control. The clamp design features easy tube insertion for both manual and automatic operations. Molded of polypropylene suitable for ETO sterilization and is stocked in white. Accepts approximately 1/4" to 1/2" OD tubing.

670705

\$25.52 pack of 100



### Flow Indicator, SAN

This flow indicator is transparent, leakproof, ultrasonically molded and fitted with a polypropylene ball. It allows an immediate visual indication of gas or liquid flow by means of the ball's rotation. The speed of the ball's rotation is dependent upon the flow of velocity. Can be used to connect tubing with different diameters from 6.5 to 10 mm (1/4" to 3/8" I.D.). For liquid flow from 50 mL/min. in horizontal position and 140mL/min. in vertical position. Minimum air flow detected is 3 liters/min. horizontal and 8 liters/min vertical. Maximum fluid temperature is 122° F (50° C).

227155

\$106.36 pack of 5

## Kartell



### Flow Indicator, Paddlewheel, SAN

This bright red paddlewheel indicates liquid or gas flow from 5 ml/sec to 95 ml/sec. The clear outer case allows for unobstructed view of the wheel which spins freely with flow. Not for use with corrosive fluids or temperature over 185° F (85° C). Can be used to connect tubing I.D. of 3/8" to 9/16" (10-14 mm) I.D.

227145

\$211.35 pack of 5

## Kartell





**Forceps - Fine Tweezers, PTFE**

They are chemically inert with excellent chemical resistance and virtually non-contaminating. The PTFE resin conforms to FDA requirements for use with Food & Beverage & USP Class VI requirements.

316525	-0100	-0150	-0200
Length mm	100	150	200
Price Each \$	17.44	20.11	28.05



**Forceps - Tweezers PMP**

*Azlon*

These strongly readjusting tweezers are available with sharp or rounded ends with fine tooth grips. Supplied in packages of six.

516555	-0001	-0002	-0003	-0004
Color	White	White	Yellow	Yellow
Ends	Sharp	Sharp	Round	Round
Length mm	115	145	180	250
Case Quantity	6	6	6	6
Case Price \$	24.91	33.68	61.44	90.18

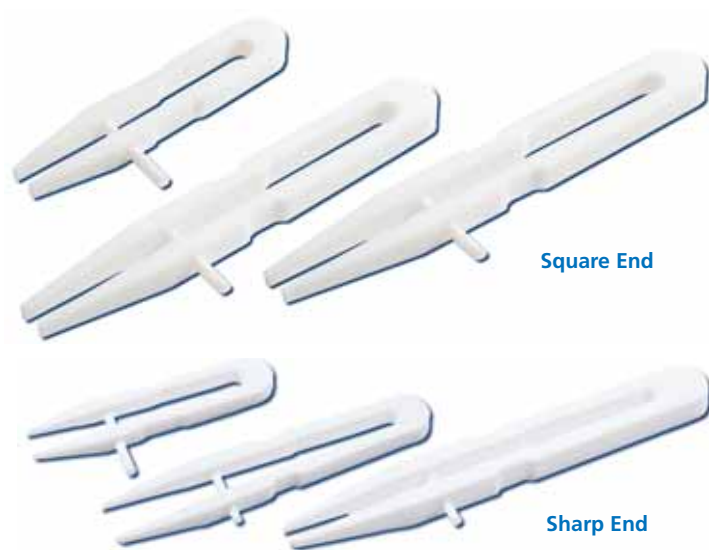

Square End

Sharp End

**Forceps - Tweezers PTFE**

Totally inert and non-contaminating. Suitable for use up to 260°C.

316504	-0000	-0001	-0002
Description End	Square	Square	Square
Length mm	100	150	200
Price Each \$	43.91	52.67	59.44

316514	-0000	-0001	-0002
Description End	Sharp	Sharp	Sharp
Length mm	100	150	200
Price Each \$	43.91	52.67	59.44



NEW

**NEW Tuff Vials**

Highly break resistant tough polycarbonate vials with polypropylene leakproof closures. Glass clear allows viewing of valuable contents, liquid or solid. Reusable and autoclavable. 180 mL can also be used as an outer protective container. Sold as each, Packs of 6 or Tray of 12.

5mL and 10mL are also ideal for leakproof shipping of reagents and buffer solutions, for packaging of serum, veterinary, pharmaceuticals, cosmeceutical and nutraceutical extracts. Use with most aromatic compounds and essential oils. Available in Packs of 20 or shrink wrap trays of 100.

626434	-0005	-0010	-0180
Size mL	5	10	180
Closure mm	20-415	20-415	54
Pack Quantity	20	20	6
Pack Price \$	\$16.00	\$17.60	\$30.96
Case Quantity	100	100	12
Case Price \$	\$80.00	\$88.00	\$61.92

## Vials - Vial Rack



### High Strength Vials, HDPE

- Leakproof
- Excellent chemical resistance

Sturdy, heavy walled vials, ideal for storing mer cury etc. Small quantities of liquid or solid samples can be taken out by pipette / spatulas without the hindrance of internal shoulders.

226425	-0005	-0010	-0030	-0060	-0090	-0180
Capacity mL	5	10	30	60	90	180
Outer Diameter mm	21	21	35	35	54.5	54.5
Inner Diameter mm	17.6	17.6	31	31	50	50
Height mm	35.7	58.4	53	94.2	63.4	109.6
Wall Thickness mm	1.7	1.7	2	1.7	2.2	2.2
Weight Each lbs	0.024	0.028	0.048	0.063	0.097	0.134
Pack Quantity	10	10	10	10	5	5
Pack Price \$	40.79	49.07	56.75	69.17	42.92	50.84



### Vials, Sample LDPE

General purpose containers with push-in friction fit hinged lids. Lightweight, wall thickness approximately 1mm. Withstands temperatures up to 80° C.

226245	-01	-02	-05	-08
Capacity ml	1	2.5	5	8
O.D. mm	8	14	15	17
Height mm	32	31.5	49	57.6
Case Quantity	100	100	100	100
Case Price \$	51.21	60.41	63.17	68.92

226245	-10	-25	-50
Capacity ml	7	20	35
O.D. mm	22.8	24.8	31
Height mm	32.9	74.5	74.5
Case Quantity	100	100	100
Case Price \$	81.59	156.96	190.47

**Kartell**

**Kartell**



**Kartell**

### Vials, Scintillation HDPE

Special grade of high density polyethylene achieves the best counting efficiency with lowest background. Quick fitting leakproof closure with quick-twist thread.

	202244	202254
Capacity ml	20	4
O.D. mm	26.5	13.8
Height mm	58.5	52.4
Case Quantity	1000	2000
Case Price \$	227.23	218.32



### Vial, Coulter® Cup

**Kartell**

Polystyrene with polyethylene lid. Container graduated at 10 and 20 ml. Tight fitting push-on lid assures leakproof fit. Closure easily opened with just one finger. Packed 200 per package, 1000/case.

202184-0001 \$184.53 case/1000

### Vials, Hinged Snap Cap LDPE

General purpose 25ml containers with push-in friction fit hinged lids. Dimensions: 55mm H x 30mm Ø. Withstands temperatures up to 80°C.

319365 \$1,508.59 case of 1000



### Scintillation Vial Rack PP - 27 mm

Welded polypropylene rack holds the included 10 standard 20 mL scintillation vials (202244 above). Rack is autoclavable and resists both nitric and hydrochloric acids. Hole diameter: 1 1/16", dimensions: 14.5"L x 15"W x 2.5"D. Additional sizes available upon request.

126304 \$162.23 each



MADE IN  
  
 U. S. A.



**Vial Caddy HDPE - 23 mm**

Heavy duty vial caddy protects up to 48 of the popular 23mm diameter glass vials. Machined from a solid block of 1.25" HDPE sheet of offering 360 degree protection during storage and transport. Supplied with a snug fitting cover and non-skid feet. Caddy Dimensions: 12"x 6"x 1.25". Cover ID: 12"x 6"x 1.5". Additional sizes available upon request.

159014

\$152.58 each

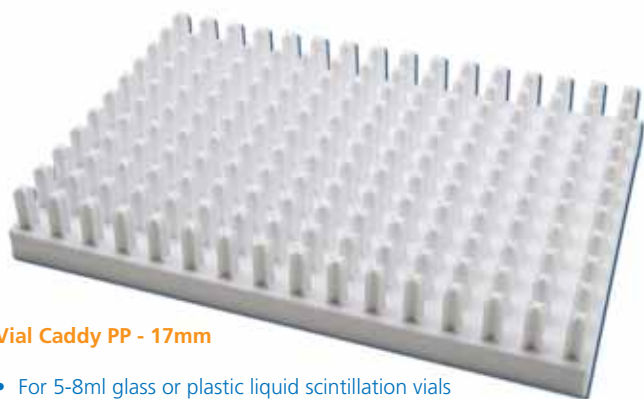

**Vial Caddy PP - 17mm**

- For 5-8ml glass or plastic liquid scintillation vials

Made of sturdy, autoclavable polypropylene for excellent chemical resistance. Holds 150 17mm diameter vials in 10 rows. Lightweight, durable and easy to clean. Dimensions: 12 3/4"L x 8 3/4"W x 1 7/8"H.

459204

\$356.17 pack of six

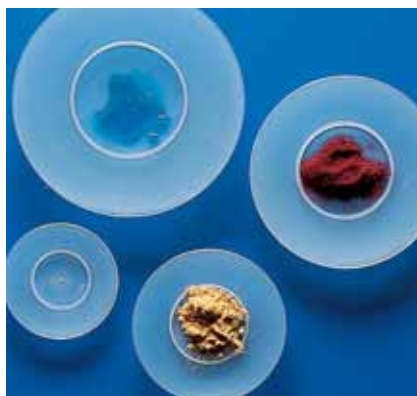

**Kartell**

**Watch Glass PP**

Provided with a stable base and made of chemically resistant polypropylene. Will withstand temperatures up to 120° C. May also be used as beaker covers.

	255235	255245	255255	255265
Diameter mm	60	80	100	125
Pack Quantity	50	50	50	50
Pack Price	114.68	147.51	188.19	226.76

**Vial Rack - Water Still**



**Water Still, Merit**



- Economical Price
- Glass construction with long life metal heating element
- Two independent safety thermostats
- Wall mountable

The Merit is the ideal choice for budget conscious laboratories that can't afford to compromise on quality. It combines economy and high performance with a host of other features which comparable stills cannot match. Built in acid addition funnel and drain stopcock allow easy descaling without dismantling the glassware.

The unique condenser design ensures that the droplets of distilled water remain in contact with the cooling coil for the longest possible time producing cold distilled water and pre-heating the boiler feed to increase efficiency. Screw threads are incorporated on all water connections so hoses can be fitted and removed easily and safely without risk of breakage. Safety features include two independent safety thermostats to prevent over heating in the event of failure of the water supply. The stand is pre-drilled to facilitate wall mounting.

Output	.4 liters/hr, single distilled
pH	.5.0 – 6.5
Conductivity, µScm-1	.3.0 – 4.0
Resistivity, mOhm-cm	.0.25 – 0.3
Temperature	.25 - 35°C
Pyrogen content *	.Pyrogen free
Water supply	.1 liter/min
	3 – 100psi (20-700kPa)
Electricity supply (single phase)	.220/240V, 50-60Hz
Power requirement	.3kW
Net weight	.25lbs
Dimensions, (w x d x h), mm	.500 x 150 x 450
	19.7" x 5.9" x 17.7"

\* Care is required to produce pyrogen free water and the output should be tested before use.

540004-0000	Merit Water Still, 220/240V	\$1,820.75 each
540014-0001	Replacement 220V Heater element 3kw	\$946.23 each
540014-0002	Replacement boiler	\$697.50 each
540014-0003	Replacement condenser	\$981.93 each
540014-0005	Gasket Kit For Water Stills	\$199.86 each

The results above confirm that the distilled water from our Merit Water Still conforms to Grade 3 water as detailed in ISO 1696: 1987.

\*pH, conductivity and sensitivity are affected by temperature and the presence of absorbed carbon dioxide. The basis of the tests is 20°C on distilled water free of carbon dioxide.

\*\*Care is needed to obtain Pyrogen-free water, and the distillate must be tested before use.

## Weighing Bottle - Wipe



### Weighing Bottles PP with PP Lids

**Kartell**

- Autoclavable, reusable translucent bottles
- Airtight, push on lids included
- No internal shoulder eliminates need for spatulas
- For liquids or solids

Reduce the tare weight correction with these light weight, autoclavable, reusable translucent bottles. Highly resistant to acid attack. Tops can be squeezed to assist pouring. Remove lid before autoclaving. Very economical compared to glass.

261154	-0001	-0002	-0003	-0004
Volume mL	20	23	30	50
O.D. mm	40	30	49	59
Height mm	29	48	29	34
Tare g	8	8	10	18
Pack Quantity	10	10	10	10
Pack Price \$	56.52	57.34	58.05	65.62

261154	-0005	-0006	-0007
Volume mL	60	190	360
O.D. mm	40	59	70
Height mm	69	88	118
Tare g	14	28	40
Pack Quantity	10	10	10
Pack Price \$	67.39	82.17	98.61



### Work Pac All-Purpose Wipes

WorkPac\* All-Purpose Wipes are an effective, economical option to handle a variety of light duty jobs. Made with 100% recycled paper, these towels are absorbent and durable leaving a streak-free surface.

626705	-0001
Number of ply	2
Ply type	Interfold
Color	White
Item Dimensions inches (cm)	10.25 x 9.25 (26 x 23)
Sheets per box	125
Box Price \$	5.79



**SEE  
Wipe Box  
Holders  
on page 106**

### Adept® Paper Wipers

- Low Particulate, non-streak cleaning
- Extra Absorbency Performance
- Sensitive and Delicate parts wiping
- Anti-static cover

Adept@Wipes...ideal for wiping applications requiring clean, delicate, low-lint performance. Soft, non-abrasive, low lint virgin tissue wipes are available in both 1-ply and 3-ply strengths. Efficient wipe sizes in attractive usage-control dispenser boxes with lint-reducing, anti-static film covers.

626705	-0002	-0003	-0004
Number of ply	1	1	3
Color	White	White	White
Dimensions inches	4.5 x 8.0	14.0 x 15.8	14.5 x 15.8
Sheets per box	280	140	90
Box Price \$	4.43	14.01	17.26



### Tuff-Job® Scrim Reinforced Wipers

- Multiple plies for more absorbency
- Superior wipe dry
- Low lint
- 100% recycled
- Polyester scrim webbing for extra strength & durability

Tuff-Job scrim reinforced wipers are the better choice for all-purpose wiping jobs where extra durability is needed; yet, cost effective. These wipers provide the best wipe-dry performance of any comparable disposable wiper, especially for glass and other smooth surfaces. Works well in grease and oil, too!

626715	-0001	-0002	-0003
Number of ply	4	4	4
Packing	Pop-up, Flat dispenser		1/4 fold, poly bag
Color	White	White	White
Dimensions inches	9.75 x 16.75	13.25 x 12	12 x 13
Sheets per box	150	900	50
Box Price \$	18.56	107.42	5.97



**Like-Rags®**

- Multiple plies for more absorbency
- Superior wipe dry
- Low lint
- 100% recycled
- Polyester scrim webbing for extra strength & durability

High performance nonwoven towel ...Like-Rags® are designed for durability, strength, and absorbency. Ideal replacements for rental shop towels and rags. Like-Rags® can be used in all cleaning and wiping situations —heavy duty machine & part cleaning, polishing or bondo removal along with adhesive cleaning.

Like-Rags are the ideal choice for applications that require resistance to solvents and virtually lint free wiping —applying aircraft solvents, wiping down print presses or plates and solvents for furniture stains. Like-Rags® eliminate the waste and cost guess work associated with industrial rags. They allow you to control costs through consistent case count, size and quality. Re-usability and durability add up to a very cost effective, value added product line!

626725	-0001	-0002
Number of ply	4	4
Ply Type	Creped	Creped
Packing	Pop-up, dispenser box (1.5 oz)	Pop-up, dispenser box
Color	White	Blue
Item Dimensions inches	9.75 x 16.75	9.75 x 16.75
Sheets per box	150	125
Box Price \$	31.95	29.21



**Golden Dusters**

- Unique stretch design
- Strong, Soft and Durable
- Specially designed pockets to catch dust and dirt
- Convenient twist-tie polybags
- Treated to attract dust
- Low Linting

Golden Dusters are the perfect choice for multi-purpose dusting applications. Both towels contain a unique structure that is designed to be stretched before dusting, creating tiny dust catching pockets. Towels are specially treated to collect maximum amounts of dust without leaving any hazardous residue behind.

626745	-0001	-0002	-0003
Packing	1/4 fold, polybag	1/4 fold, polybag	1/8 fold, polybag
Color	Yellow	Yellow	Yellow
Dimensions inches	16 x 24	12 x 16.75	24 x 24
Sheets per box	50	50	50
Box Price \$	20.45	13.04	32.93



**Dusterz® Floor Cloth**

- Superior dust / dirt pickup and retention
- Strong Fabric –Greater stretchability
- Leaves no oily residue
- Available in two sizes: Hand & Floor dusters
- Anti-static properties –helps to neutralize static electricity

Dusterz® —dry, pretreated anti-static dusting and cleaning cloths. Cloths are oil and silicone free, which means no oily residue left behind to stain documents, streak polished surfaces or create slippery spots on floors. Dry pretreatment reduces the use of aerosol, liquid cleaners and chemicals which helps reduce dusting and cleaning time.

626735	-0001
Packing	1/4 fold, polybag
Color	White
Item Dimensions inches	16 x 24
Sheets per box	50
Box Price \$	28.03



**PUSH-UP Box™, PS**

- Accessible and portable
- Use wherever ergonomically desirable
- Protects tissues from spills in the workplace
- Single-piece construction
- Injection molded, high impact polystyrene
- Made in U.S.A.

476244 \$25.78 each

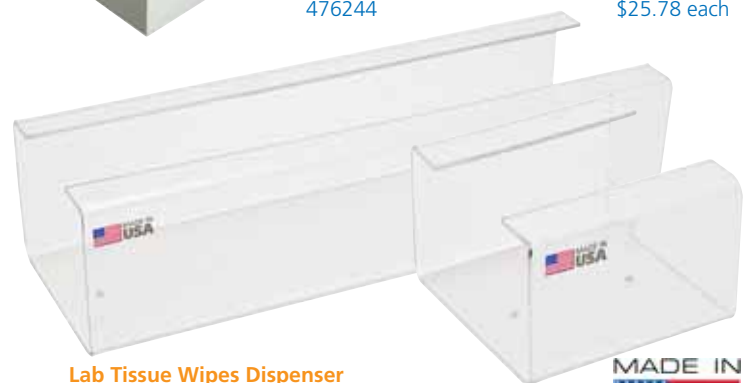

**Lab Tissue Wipes Dispenser**

Acrylic clear holder adds extra weight for one-hand dispensing of tissue wipes. Wall or bench mount with either two strips of double sided tape or mounting screws (not included). For small and large tissue (page 105) boxes.



	176224	176234
Holds Kimwipe Box Size	Small	Large
Length inches	5	15 3/8
Width inches	5 1/8	5 1/4
Height inches	3 3/8	4
Price Each \$	17.69	22.34

# Alphabetical Index

Description	Page
4 Way Connector	101
Adapter/Connector	101
Adept Wipes	106
Analytical Funnel	60
Angle Beta Shield	16
Autoclave Sterility Tape	91
Bag	8
Bag, Zipper Seal	8
Baritainer	8,34,35
Basket, Dipping	52
Basket, Draining	53
Basket, Pipette	73
Beaker	12-Sep
Beaker Bar	87
Beaker Cover	11
Beaker Set	9,11
Beaker with Handle	12
Beaker, Graduated	9
Beaker, Griffin	11
Beaker, PTFE	11
Beaker, PTFE Heatable	12
Beaker, Square Ratio	9
Beaker, Tapered	10
Bellows Dropping Bottle	18
BenchGuard	67
Benchtop Beta Shield	16
Beta Block	15
Beta Desktop Box	14
Beta Pipette Bin	63
Beta Radiation Protection	13-17
Beta Shield	16
Beta Storage Box	14
Beta Storage Cabinet	13
Beta Waste Bin	15
Bin, Beta Waste	15
Bin, Mobile Floor	14
Bin, Mobile Floor	14
Bin, Pipette Tip	15
Bin, Station Small	72
Bio-bin	54,55
Biohazard, Shield	80
Biological Stain Washbottle	29
Blade, Plain End	89
Blade, Square End	89
Block, Beta	15
Block, Test Tube Beta	15
Blood Bank Rack	98
Bottle Carrier	32
Bottle Pourer	32
Bottle, Bellows	18
Bottle, Buttress	20
Bottle, Concertina	26
Bottle, Dispensing	17-19
Bottle, Dropping	17
Bottle, Dropping PTFE	51
Bottle, Economy	20
Bottle, Eye Wash	56
Bottle, General Purpose	20-23
Bottle, Graduated	21
Bottle, Grey NM	22
Bottle, HDPE Tamper	26
Bottle, Laboratory	24-25
Bottle, Large	20
Bottle, LDPE Graduated	22
Bottle, Narrow Mouth	25
Bottle, Octagonal Media	23
Bottle, PET	23
Bottle, Plug Cap	22
Bottle, Plunger	17
Bottle, PP Graduated	22
Bottle, PTFE	21
Bottle, PVC	23
Bottle, Quick Mist	19
Bottle, Ribbon Spread	18
Bottle, Round PP	22
Bottle, Safety	26
Bottle, Sealer	18
Bottle, Space Saver	41
Bottle, Spouted	18
Bottle, Square	26,27
Bottle, w/ Handle	21
Bottle, Wash LDPE	27-31
Bottle, Weighing	32,106
Bottle, Wide Mouth	24
Bottle/Jug, w/ Handle	36
Bowl, Round	92
Box, Beta Storage	14
Box, Bio-bin	54
Box, Burn Up Bin	54
Box, Desktop Beta	14
Box, Dry Waste	14
Box, Freezer	16
Box, Glass Disposal	54
Box, Non-Hazardous Waste	54
Box, Pipette Sterilizing	72
Box, Pipette Storage	72
Box, Plastic Recycle	54
Box, Safety PC	92
Box, Sample	14,15
Box, Storage	15
Box, Storage for Beta	13
Box, Tote	91
Box, Wet Waste	14
Buchner Funnel	63
Buchner Funnel Disc	62
Buchner Funnel Support	62
Bucket, Heavy Duty	69
Bucket, Ice	32
Burette Clamp	33
Burette Rack	77
Burette, Automatic Titrating	33
Burette, Graduated	33
Burn Up Bin	54
Cabinet, Beta Storage	13
Cabinet, Desiccator	49
Cabinet, Nitrogen Purge	49
Cabinet, Slide	82
Cabinet, Slide Casters	82
Caddy, Vial	104
Carboy	34-37
Carboy Spill Tray	37,92
Carboy w/ Spigot HDPE	36
Carboy, Heavy Weight	35
Carboy, Light Weight	35
Carboy, Heavy	35,36
Carboy, LDPE	36,37
Carboy, Octagonal	36
Carrier, Bottle	32
Carrier, Kaddy	94
Carrier, Safety Centrifuge Tube	98
Cassette, Tissue Embedding	83
Caster, Slide Cabinet	82
Centrifuge Tube, Sterile	95
Check Valve	101
Chiller, DynaQube	38
Clamp	102
Clamp, Burette	33
Close-it Labels	8,65,66
Color-Coded Stir Bar Kit	87
Concertina Bottle	26
Conical Cylinder	46
Conical Stoppers	59
Connector Kit	102
Connector Stopper	100
Connector, 4 Way	101
Connector, Equal Y	101
Connector, L	102
Connector, Straight	101
Connector, T	101
Connector, Y	101
Connector/Adapter	101
Container	38-42
Container, Disposable	41
Container, Hinged Lid	39
Container, Non-Pyrogenic	42
Container, PETE	39
Container, PP	38,39
Container, PS	39
Container, PS	42
Container, Snap Cap	40
Container, Storage	40
Coulter Cup	104
Cover, Beaker	11
Cover, Instrument	68
Cover, Microscope	83
Cover, Slide Tray	82
Crock w/ Cover	52
Cross Head Stir Bar	87
Crucible, PTFE	42
Cup, Coulter	103
Cup, Sample	78
Cutting Board	43
Cuvette Cap	43,45
Cuvette Holder	43
Cuvette Stirrer	43
Cuvette, Clear Side	44
Cuvette, UV Ultra-Micro	45
Cuvette, UV-VIS Macro	44
Cuvette, UV-VIS Semi-Micro	44
Cuvette, VIS Macro	44
Cuvette, VIS Semi-Micro	44
Cylinder, Certified	45
Cylinder, Conical	46
Cylinder, Molded	46
Cylinder, Printed	47
Cylinder, Squat	48
Delivery Tube	48
Desiccator	50
Desiccator Cabinet	49
Desiccator Plate	50
Detergent, Lipsol	50
Dippas®	50
Dipper	51
Dipping Basket	52-53
Dipping Kit	51,69
Disc, Buchner Funnel	62
Disconnects	100
Dish, Evaporating	56
Dish, Slide Staining	82
Dispenser, Para Film	70
Dispenser, Slide	82
Dispenser, Wipe	106
Dispensing Bottle	17-19
Disposable Container	41
Disposal Box, Burn Up	54
Disposal Box, Glass	54
Draining Basket	53
Driplok Washbottle	28
Dropping Bottle	17
Dropping Bottle, PTFE	51
Dropping Pipette	55
Drum Sampler	78
Dry Waste Box	14
Drying Rack	55,56
Drying Rack, PS	47,55,77
Dura-Clamp	38,102
Dusterz	107
DyNACycler	90
DynaQube, Chiller	38
Equipment Cover	68,82
Emergency Eye Wash Station	56
Enzyme Freezer Box	16
Equal Y Connector	101
Erlenmeyer Flask	57,58
ESCO Tubing	100
Evaporating Dish	56
Eye Wash Bottle	56
Eye Wash Station	56
Faucet	35,41,84
Filler, Pipette	75
Filter, Levo Pipette	75
Flask	57-59
Flask Stand	59
Flask, Erlenmeyer	57,58
Flask, Sterile	57
Flask, Volumetric	58,59
Flip & Spray Bottle	19
Floor Cloth	107
Flow Indicator	102
Forceps	60,103
Freezer Box	16
Funnel	60-63
Funnel Set	60-62
Funnel, Analytical	60
Funnel, Anti-Splash	62
Funnel, Buchner	63
Funnel, Industrial	61
Funnel, Large	61
Funnel, Light Weight	60
Funnel, Long Stem	61
Funnel, Mini	20
Funnel, Powder	62
Funnel, PTFE	62
Funnel, Utility	61
Gamma Protection	63
GHS Washbottle	30
Glass Disposal Box	54
Glass Joint Sleeves	64
Golden Dusters	107
Graduated Bottle	21
Grey Bottle	22
Griffin Beaker	11
High Strength Vial	104
Histology Tray	83
Holder, Pipette	74
Holder, Pipette Filler	74
Holder, Pipettor	74
Holder, Rack	99
Hybridization Tube Rack	98
Hydrometer Jar	64
Hydrometer Rack	64
Ice Bucket	32
Imhoff Cone Rack	64
Indicator, Flow	102
Industrial Funnel	61
Inoculating Loops	65
Instrument Dust Cover	68,82
Jar	40
Jar Hydrometer	64
Jar, Light Weight	39
Jar, PP	38
Jar, PS	39
Jar, Round	38
Jar, Slide Staining	81,82
Jug w/ Handle	35
Jug, Squat w/ Handle	27
Jug, Tall Bottle	27
Kaddy Carrier	94
L Connector	102
Lab Tissue Dispenser	107
Label	65,66
Label Dispenser	65
Labware Starter Pack	1
Ladle	79
Levo Pipette Controller	75
Levo Pipette Filter	75
Like Rags	107
Lipsol Detergent	50
Liquid Sampler	78
Long Stem Funnel	61
Loops Inoculating	65
Magnetic Stirrer	90
Marker Pen	28

Matting	67	Rack, Imhoff Cone	64	Spot Plate	85	Tote Box	90-92
Matting, Slip-Stop	67	Rack, Micro Tube	97	Spouted Bottle	18	Tray	92-94
Matting, BenchGuard	67	Rack, Microcentrifuge Tube	97	Square Bottle	26,27	Tray Lid	93
Media Bottle	23	Rack, Micropipette	71	Square Media Bottle	23	Tray, Bottle	95
Melting Point Device	68	Rack, Microtube	14	Staining Rack	82	Tray, Carboy	37,92
Melting Point Tubes	68	Rack, MiniFIX	71	Stand, Flask	59	Tray, Deep	91
Merit Water Still	105	Rack, Pipette	72	Stand, Petri Dish	70	Tray, Draining	91
Micro Centrifuge Tube	95	Rack, Rodac Plate	77	Stand, Pipettor	74	Tray, High Impact	94
Microcentrifuge Tube Rack	97	Rack, Sample Cup	78	Stand, Retort	33	Tray, Histology	83
Micropipette Rack	71	Rack, Smooth	96	Starter Pack, Labware	1	Tray, Lab Items	94
Microscope Cover	68,82	Rack, Staining	82	Station, Emergency Eye Wash	56	Tray, Microscope Slide	81
Microscope Slide Block	81	Rack, Test Tube	96,97	Station, Pipette Stand	74	Tray, Pipette	95
Microscope Slide Tray	81	Rack, Thermometer	77	Stir Accessories	88-90	Tray, Rectangular	93,94
Microtube Rack	14	Rack, Vial	103	Stir Bar Kit	85	Tray, Round	93
Miniature Stopcock	90	Rags	107	Stir Bar Kit, Color-Coded	87	Tray, Sample Bottle	95
MiniFIX Rack	71	Retort Stand	33	Stir Bar Retriever	88	Tray, Section	94
Mobile Floor Bin	14	Retriever, Stir Bar	88	Stir Bar, Beaker	87	Tray, Slide	82
Modular Sampling Kits	51,69	Ring, Tissue Embedding	83	Stir Bar, Cross Head	87	Tray, Stacking	92
Nitrogen Purge Cabinet	49	Rod, Stirring	84,88	Stir Bar, Disposable	85	Tray, Utility	91
Non-Hazardous Waste Box	54	Rodac Plate Rack	77	Stir Bar, Egg Shaped	85	Tube Rack, Micro	97
Non-Pyrogenic Container	42	Round Bowl	92	Stir Bar, Extra Large	86	Tube, Micro Centrifuge	95
Non-Return Valve	100	Round Tray	93	Stir Bar, Micro	87	Tube, Melting Point	68
Paddle	68,69	Safety Box	92	Stir Bar, Octagonal	85,87	Tube, Sterile Centrifuge	95
Pail	69,70	Safety Centrifuge Tube Carrier	98	Stir Bar, Octagonal Color-Coded	87	Tube, Test	95
Pail, Graduated	69	Safety Shield, U Frame	17	Stir Bar, Octagonal Micro Colored	87	Tubing Connector Kit	102
Pail, Heavy Duty	69	Sample Box	14,15	Stir Bar, Round	86	Tubing Cutter	100
Pans	41	Sample Cup	78	Stir Bar, Triangular	88	Tubing, ESCO	100
Paper Wipers	106	Sample Cup Rack	78	Stir Bar, Vane	87	Tubing, FEP	99
Para Film Dispenser	70	Sample Cup Storage Unit	78	Stirrer	84	Tubing, LDPE	100
Pegs, Drying Rack	47,55,77	Sample Safe Seals	66	Stirrer Kit	51,79	Tubing, Vinyl	99
Pen, Marker	28	Sample Vial	104	Stirrer Shaft	89	Tuff Job Wipe	106
Petri Dish Stand	70	Sampler, Drum	78	Stirrer, Propeller	89	Tuff Vials	103
Pipette	71,72	Sampler, Liquid	78	Stirrer, Cuvette	43	Tweezer	60,103
Pipette Accessories	72,73	Sampling Kit	78,79	Stirrer, Magnetic Non-Electric	89	Utility Funnel	61
Pipette Basket	73	Sampling Kit	51,79	Stirrer, PP	88	Utility Tray	91
Pipette Bin Beta	63	Scaper/Spatula	84	Stirrer, Screw Propeller	89	Vacuum Pump	76
Pipette Controller, Levo	75	Scintillation Vial	104	Stirring Head Kit	88	Vadosa	75
Pipette Filler	75	Scoop	79,80	Stirring Padde	68	Valve, Check	101
Pipette Filler Holder	74	Scoop, Economy	80	Stirring Paddle	68	Valve, Non-Return	101
Pipette Holder	74	Scoop, Flat Bottom	80	Stirring Rod, Flat	88	Vane Bar	87
Pipette Jar	73	Scoop, Ladle	79	Stirring Rod, PP	84	Vial	103,104
Pipette Rack	71,72	Scoop, Measuring Flat	80	Stirring Rod, Rounded	88	Vial Caddy	105
Pipette Stand Work Station	74	Scoop, PTFE	79	Stirring Rod, Steel Core	88	Vial Rack, Scintillation	103
Pipette Sterilizing Box	72	Seal	66	Stopcock	99	Vial, Heavy Duty	103
Pipette Storage Box	72	Seal-it Seals	66	Stopper, Conical	59	Vial, High Strength	104
Pipette Tip Bin	15	Section Tray	94	Stopper, Push On	78	Vial, Sample	104
Pipette Tips	73	Separatory Funnel Support	62	Stopper, Test Tube	95	Vial, Scintillation	104
Pipette Washer	73	Shaft Stirrer	89	Storage Box	15	Vial, Tuff	103
Pipette, Dropping	55	Shield, Beta	16	Storage Box For Beta Emitters	13	Volumetric Flask	58,59
Pipette, Graduated	71	Shield, Body	16	Storage Container	40	Washbottle	27-31
Pipette, Sterile	71	Shield, Hinged Beta	17	Storage Station	72	Washbottle, Autoclavable	29
Pipette, Volumetric	71	Shield, PC	90	Storage, Sample Cup Unit	78	Washbottle, Biological Stain	29
Pipettor Accessories	74	Shield, Safety Large U Frame	17	Straight Connector	101	Washbottle, Colored Cap	30
Pipettor Controller	75	Shield, Small	16	Student Funnel Set	61	Washbottle, Deionized	29
Pipettor Stand	74	Shield, Splash	80	Support, Buchner Funnel	62	Washbottle, Distilled	29
Pi-Pump	75	Sleeve, Glass Joint	64	Support, Separatory Funnel	62	Washbottle, Driplik	28
Plastic Recycle Box	54	Slide Accessories	81-83	Swab, Cotton	90	Washbottle, GHS	30
Plastic Ties	8	Slide Block	81	Swab, Enviro	90	Washbottle, Integral	31
Plate, Desiccator	50	Slide Cabinet	82	T Connector	101	Washbottle, Needle	27
Plate, Spot	85	Slide Dispenser	82	Tamper Evident, HDPE Bottle	26	Washbottle, Sloped	31
Poly Crock	52	Slide Staining Dish	82	Tamper Proof Seals	66	Washbottle, Tracker	28
Pourer, Bottle	32	Slide Staining Jar	81,82	Tank, Dipping Basket	52	Washbottle, Water	29
Powder Funnel	62	Slide Tray	81,82	Tank, Stackable	92	Washer, Pipette	73
Pump	76	Slide Tray Cover	82	Tape, Autoclave Sterility	90	Watch Glass	105
Push On Stoppers	78	Slip-Stop Matting	67	Test Tube Block, Beta	15	Water Jet Filter	76
Push Up Box Dispenser	107	Sloped Washbottle	31	Test Tube Rack	96,97	Water Still, Merit	105
Quick Mist Bottle	19	Smooth Rack	96	Test Tube	95	Weighing Bottles	106
Rack Holder	99	Snap Cap Bottle	23	Test Tubes Stoppers	95	Wet Waste Box	13
Rack Test Tube	96	Snap Cap Container	40	Thermal Cycler	90	Wipe Dispenser	107
Rack, Blood Bank	98	Space Saver Bottle	41	Thermometer Rack	77	Wipe	106,107
Rack, Burette	77	Spatula	83,84	Tips, Pipette	73	Work Station Storage	72
Rack, Drying	47,55,56,77	Spatula/Scraper	83,84	Tissue Dispenser	107	Work Station, Pipette	74
Rack, Drying PS	47,55,77	Spigot	36	Tissue Embedding Cassette	83	Workpak Wipe	106
Rack, Freezer	97	Splash Shield	16	Tissue Embedding Ring	83	Y Connector	101
Rack, Hybridization Tube	98	Sponge, Stainless Steel	84	Tissue Embedding Sponge	83	Zipper Seal Bag	8
Rack, Hydrometer	64	Sponge, Tissue Embedding	83	Titration Burette, Automatic	33		







## Custom Plastic Fabrication

MADE IN



U. S. A.

Dynalon's plastic fabrication department fabricates many **laboratory products** in this catalog. Stock products ranging from our extensive line of desiccators on page 49 to the often customized spill containment trays on page 93.

*We have the capabilities to produce custom jobs following the exact requirements of your application.*

A few examples of our custom laboratory jobs include trays of all sizes, tanks, fume hoods, cabinets, chambers, racks and thousands of other plastic items.

We are capable of producing prototypes as well as high volume job runs. We would be happy to provide you with a **free quotation** and any technical assistance you may require throughout your project.

Dynalon works with virtually all types of plastics. We stock a large inventory of sheet, rod, tubing, extrusions, fittings, plastic hardware, perforated sheet, etc...

**Please telephone our customer service department at 800-334-7585 for more information.**



Custom fabricated of perforated HDPE **dipping basket** was used for coating a lens in the Hubble Telescope.  
Unit dimensions: 6' long x 3' wide x 4' deep



Custom fabricated fully functional **laboratory sink** was made to the strict dimensions and requirements of our customer.  
Unit dimensions: 6' tall x 5.5' wide x 2.5' deep



**Volumetric Flasks  
with Stoppers, PMP**  
Page 59

### Flasks: 57 - 59

- Erlenmeyer Flasks, PC
- Erlenmeyer Flasks, PP
- Kartell Erlenmeyer Flasks, PP
- Volumetric PFA, PMP & PP Flasks
- Flask Stand

### Funnels: 60 - 63

- Analytical Funnels, PP
- Anti-Splash Plastic Funnels, LDPE
- Kartell Buchner Funnels, PP
- General Purpose Plastic Funnels
- Lightweight Plastic Funnels
- Plastic Powder Funnels, PP
- Plastic Mini Funnel, PP



**Buchner Funnels, PP**

Page 63

### Pipettes & Pipettors: 71-75

- Single Use & Reusable Pipettes
- MiniFIX Micropipettes
- Pipette Racks & Dispensers
- Pipette Washing Set
- Pipette Tips
- Pipettor Controllers & Accessories



**Levo Pipette Controllers**

Page 75

### Stirring Bars: 85 - 89

- PTFE Stir Bars, all shapes and sizes
- Disposable Stir Bars
- Colored Stir Bars
- PTFE Stir Bar Kits
- PTFE Stirring Bar Retriever Rods
- Stirrers with Blades, PTFE & PP



**NEW Tray, Sample Bottle, PVC**  
Page 95

### Trays: 92 - 95

- Carboy Spill Tray
- Rectangular & Round Trays
- Rectangular & Round Tray Lids
- Dispensing Trays
- Storage & Transport Trays
- Custom Sizes Available

### Tubing & Accessories: 99 - 102

- Vinyl, FEP and LDPE Tubing
- Tubing Cutters
- Tubing Accessories
- Extensive Tubing Connector Selection
- Dura-Clamp Tubing Flow Valve
- Flow Indicator



**Dura-Clamp® Tubing Flow Valve**

Page 102



**Dynalon**<sup>®</sup>  
Labware  
quality . value . service

175 Humboldt Street, Suite 300 . Rochester, NY 14610

Telephone 800-334-7585 . Fax 585-334-0241

[www.dynalon.com](http://www.dynalon.com)